

CLEAN WATER
STORE

Clean Water Made Easy

www.cleanwaterstore.com

7500-Rev4 Pro-Ox Lite Filter

Installation Guide



Thank you for purchasing a Clean Water System! With proper installation and a little routine maintenance your system will be providing iron free water for many years.

Please review this start-up guide entirely before beginning to install your system and follow the steps outlined for best results.

The Pro-OX Iron Filter media must be activated with a 1 cup of unscented liquid chlorine bleach (such as Clorox) when first installing it. Read instructions for more information. It is easy to do, but a critical step.

The Pro-OX media produces very small particles (fines) when the system is first installed. Bring the water pressure up VERY slowly during the initial backwash by opening inlet valve slowly to avoid pushing the media up into the control head.

Performing multiple backwashes at start-up is an important step.

You should also not bring any other systems online (i.e. softeners, filters, etc.) until the Pro-Ox system is fully flushed. Depending on the water quality, this may take several backwashes and a week or two of normal water use.

The Pro-OX media contains dust. Use paper mask and ventilate area to avoid breathing dust when first pouring the media into the tank.

Minimum 30 PSI required. Maximum pressure 90 PSI.

For indoor installation. Protect from sunlight, rain, and freezing.

Questions?

 **Call us toll-free:** 1-888-600-5426 or 1-831-462-8500

 **Email us:** support@cleanwaterstore.com

 **See more information on our website:** www.cleanwaterstore.com/resources

Table of Contents

Packing Lists	4
Pre-Installation	5
Best Practices for Piping & Drain Installation	5
How the Bypass Valve Works	6
Installation of Your System in Copper or Metal Piping Systems	6
How Your Pro-Ox Iron Filter Works	7
Diagram of Typical Installation	7
Tank Assembly and Installation Instructions	8
Programming Your Valve	10
Set Time of Day	11
Set Date	11
Set Capacity	12
Start the First Backwash	12
Advanced Programming Mode	13
Advanced Program Recommended Settings	14
Maintenance	15
Limited Warranty	16

7500-Rev4 Pro-Ox Filter Installation & Startup Guide

Packing Lists

All systems include:

7500-REV4 control valve, bypass valve, small tube of silicone grease, power supply, funnel for adding media, top screen, start-up guide, and items included in one of the following options:

Find Your Size System to See What is Included:

Pro-Ox Filter 0.75 cubic foot size

8" x 44" filter tank with distributor tube
9 lbs. filter gravel
63 lbs Pro-Ox Lite media

Pro-Ox Filter 1.5 cubic foot size

10" x 54" filter tank with distributor tube
16 lbs. Filter gravel
126 lbs. Pro-Ox Lite media

Pro-Ox Filter 1.0 cubic foot size

9" x 48" filter tank with distributor tube
12 lbs. filter gravel
84 lbs. Pro-Ox Lite media

Pro-Ox Filter 2.0 cubic foot size

12" x 52" filter tank with distributor tube
20 lbs. filter gravel
168 lbs. Pro-Ox Lite media

Pro-Ox Filter 2.5 cubic foot size

13" x 54" filter tank with distributor tube
35 lbs. filter gravel
210 lbs. Pro-Ox Lite media
External Drain Line Flow Control 10 PM

What to Do if Your Tank is Not Level Out of the Box:

Your filter tank base is not glued to the bottom of your tank. Occasionally tank bases will become tilted during shipment.

If you find that that your tank does not sit level on the floor, you can easily adjust it by holding the empty tank and tap it on a concrete or solid floor once or twice to level it.

7500-Rev4 Pro-Ox Filter Installation & Startup Guide

Pre-Installation

1. Review your packing list and make sure you have received all the parts before installation.
2. If you are going to be turning off the water to the house and you have an electric water heater, shut off the power to the water heater before beginning installation in case water heater is accidentally drained.
3. Pick a suitable location for your filter system on a dry level spot where it won't be exposed to freezing temperatures. A minimum of 20 PSI is required. Maximum pressure is 90 PSI.
4. Get all of your plumbing parts together before beginning installation, and make sure you have received all of your packages before beginning or scheduling an installation. Installation typically takes 3 to 5 hours. However, after installation the filter system must be allowed to run through a complete backwash and rinse cycle.

Best Practices for Piping & Drain Installation

1. Make sure to connect the Inlet from your water source and outlet, following arrows on control valve bypass.
2. Make sure there is a working gate or ball valve before the system and also one after as well as a bypass valve.
3. A hose bib (which is a faucet to which you can attach a garden hose) is strongly recommended after your filter system and before the second ball valve. This makes it easy to rinse your filter system on start-up and gives you a place to test the water.
4. If you will be using copper piping, do not sweat the copper pipe directly on to the 7500-REV4 control valve.
5. To connect drain line to drain, use an air-gap connection, so that if your sewer or septic tank backs up, it cannot cross connect with the drain tubing.
6. The pipe connectors are 1" male pipe thread but you can add a reducer to reduce to $\frac{3}{4}$ " pipe with common pipe fittings if needed.
7. Make sure bypass valves are closed (system is in bypass) when you first start installing and keep on bypass until you are ready to start it up with the first backwash.



7500-Rev4 Pro-Ox Filter Installation & Startup Guide

How the Bypass Valve Works

Turn knob so the valve is bypassed when installing.

When you go to start up system turn the bypass SLOWLY to let water in and put in service.



By-Passed



In Service

Installation of Your System in Copper or Metal Piping Systems

If your new filter system is to be installed in a metal (conductive) plumbing system, i.e., copper, or galvanized steel pipe, the plastic components of the system will interrupt the electrical continuity of the plumbing system.

As a result, any stray currents from improperly grounded appliances downstream or potential galvanic activity in the plumbing system can no longer ground through the contiguous metal plumbing.

Some homes may have been built in accordance with building codes, which encouraged the grounding of electrical appliances through the plumbing system.

Consequently, the installation of a bypass consisting of the same material as the existing plumbing, or a grounded “jumper wire” bridging the equipment and reestablishing the contiguous conductive nature of the plumbing system must be installed prior to your systems use.

This is simple and easy step to take if you are installing your water treatment system into copper piping.

A simple ground jumper wire with a pipe clamp can be purchased at any Home Center, or hardware store etc. for a few dollars.

7500-Rev4 Pro-Ox Filter Installation & Startup Guide

How Your Pro-Ox Iron Filter Works

Water enters the top of the tank and flows down through the media and up the distributor tube.

During backwash the flow of water is reversed and water flows down the distributor tube and up through the media, lifting and expanding the Pro-Ox media.

During the backwash the Pro-Ox is cleaned by the action of the water flowing through it.

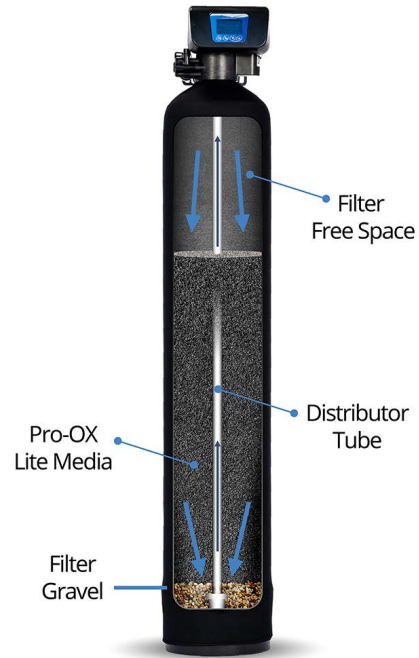
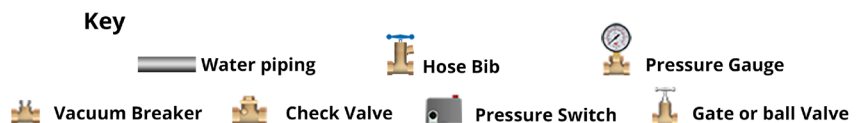
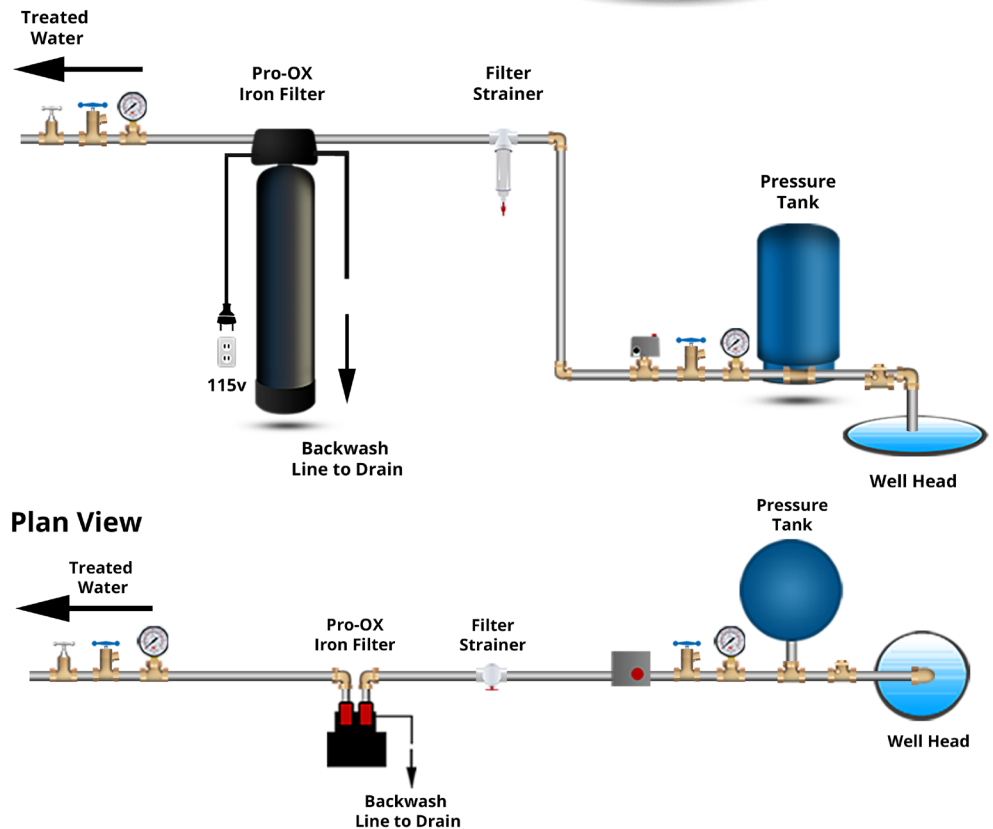

Diagram of Typical Installation



7500-Rev4 Pro-Ox Filter Installation & Startup Guide

Tank Assembly and Installation Instructions

1. Wrap the top of distributor tube with electrical or duct tape so that no gravel or Pro-OX media will go down the distributor tube.
2. Add the filter gravel that came with your order. You want the gravel to cover the bottom distributor screen before adding the Pro-OX media.
3. Next add Pro-OX media, tank should be about 2/3rds full of media.
4. Remove tape from top of distributor tube. Be careful not to pull up distributor tube.
5. **Add 1 cup of regular chlorine bleach and fill tank completely with water.** Allow media to soak for 1 hour but 24 hours or more is OK.
6. Add a small amount of silicone grease to the inner O-ring, where the distribution tube goes.
7. Next, install the top screen by inserting upwards and rotating to lock in place. (This is a funnel-shaped plastic screen that locks into the bottom side of control valve.)
8. Lubricate the main tank O-ring with silicone grease and screw on the 7500-Rev4 control valve carefully. Do not use pipe-joint compound, vegetable oil, Teflon tape, or Vaseline or other greases to lubricate tank threads.
9. Connect bypass assembly with 1" pipe connectors to control valve install black clips and make sure valve is in bypass.
10. Insert meter cable into meter cable port on bypass.

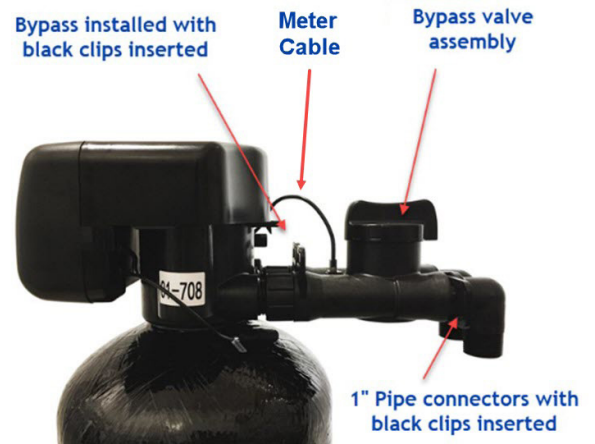
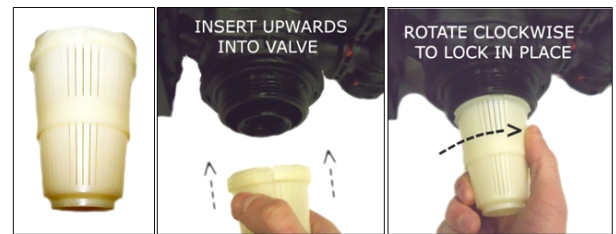

7500-Rev4 Pro-Ox Filter Installation & Startup Guide

11. Install inlet and outlet piping (see flow arrows on valve).
12. Hook up drain line tubing to drain. If needed heat up the tubing with warm water or a hair dryer to make it easier to slip over the barbed fitting on the drain port.
13. If you have 1.5 CF or 2.0 CF model, use the External Drain Line Flow Control included with your order.
14. If you are in earthquake zone, strap your backwash filter tank to wall with metal strapping.
15. Proceed to programming your 7500-Rev4 control valve timer and backwash frequency.

IMPORTANT: you must program the time and then start a backwash and rinse. The filter system must

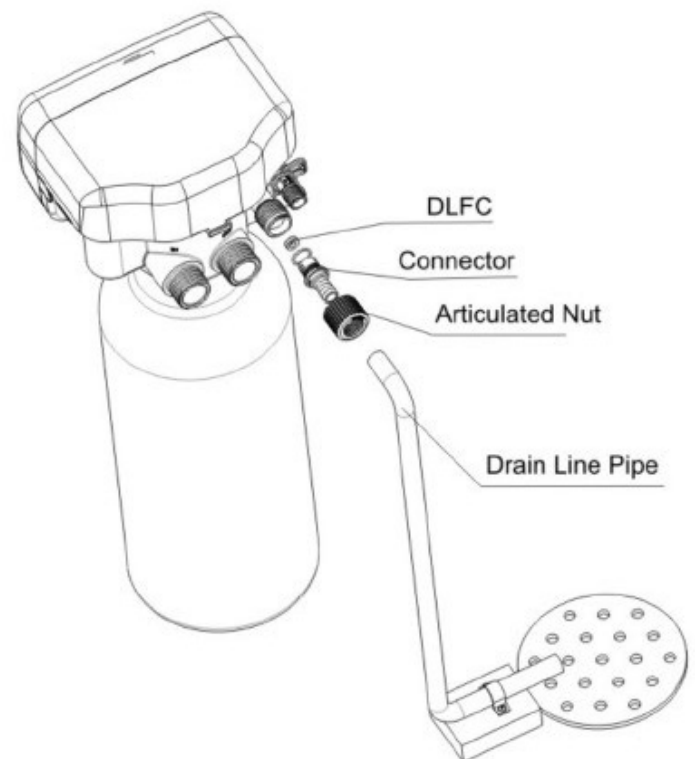
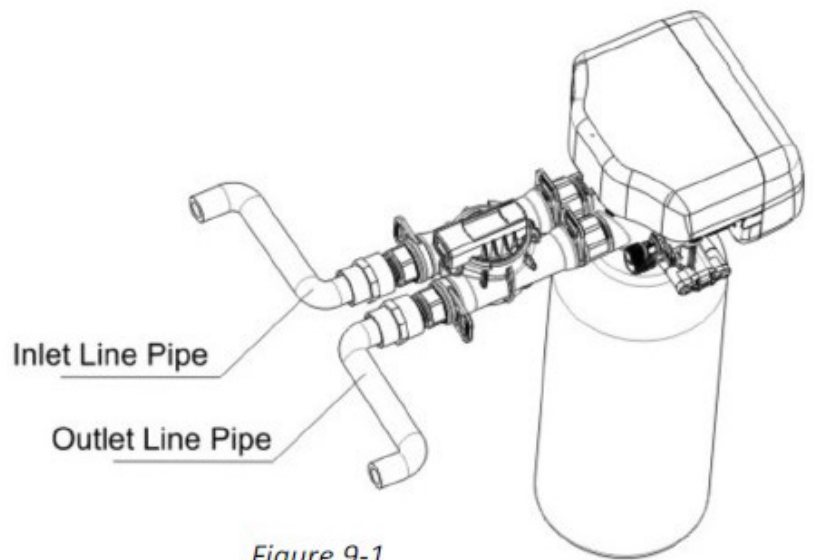

7500-Rev4 Pro-Ox Filter Installation & Startup Guide

Programming Your Valve



How to Start a Manual Backwash: Press the Back / Regen button

Pressing **"Back Regen"** at any time results in an immediate manual regeneration.

Pressing and holding for 3 seconds, when system is locked, results in a delayed regeneration at the preselected time.

Extended Power Outage Indicator

If power outage exceeds 3 days, the time-of-day indicator "_" will flash 12:12. The current time of day needs to be re-set. All other set parameters remain stored in memory. The valve will resume to operate from the point of the power outage.

Lockout Function

Keypad will lock after 5 minutes without use. To access the parameter changes, press and hold **"Up"** and **"Down"** buttons simultaneously for 3 seconds to unlock.

NOTE: To start all you need to do is set current time and date. All other parameters have been preset for you.

7500-Rev4 Pro-Ox Filter Installation & Startup Guide

Set Time of Day

1. If LOCK icon is lit, press, and hold both **UP** and **DOWN** buttons for 3 seconds to unlock keypad.
2. Then press the **MENU/CONFIRM** button to enter the main menu.
3. Press DOWN button to scroll down to and select **"Set Time of Day"**
4. Press the **MENU/CONFIRM** button again to change time of day (Hour will flash)
5. Adjust hour by using DOWN or UP buttons.
6. Press the **MENU/CONFIRM** button again to change minutes (Minutes will flash)
7. Adjust minutes by using DOWN or UP buttons.
8. Press Back/Regen



Set Date

1. If not in the main menu, press the **MENU/CONFIRM** button to enter the main menu.
2. Press DOWN button to select and scroll down to **"Set Date"**
3. **Month:** Press the **MENU/CONFIRM** button again to change time of day (Month will flash) and adjust to current Month date by using DOWN or UP buttons.
4. **Day:** Press the **MENU/CONFIRM** button again to change Day date (Day date will flash) and adjust to current day date by using DOWN or UP buttons.
5. **Year:** Press the **MENU/CONFIRM** button again to change Year date (Year date will flash) and adjust to current Year by using DOWN or UP buttons.
6. Press **BACK/REGEN** button to save current date and go back to menu.
7. Continue to review and/or change the remaining settings (as follows)

7500-Rev4 Pro-Ox Filter Installation & Startup Guide

Set Capacity

This refers to the number of gallons your 7500-Rev4 is set to backwash. Default is 1200 Gallons. This means that your filter will backwash every 1200 gallons of water used, OR every 4 days, whichever comes first, since your Maximum Days for Regen. Is set to every 4 days as well.

Set Rinse Frequency Not used. Keep or change to F:00

Set Regen Time This is the time your system will backwash. Default is 2:00 AM

Set Backwash Time Length Set for 10 minutes. This is the first cycle.

Set B. S. R. Time Not used. Keep or change to 0 minutes.

Set Fast Rinse Time Set for 8 minutes.

Set B. R. Time Not used. Keep or change to 0 minutes.

Maximum Days for Regen. This refers to the days between each backwash, also known as "Regeneration". Set to every 4 days. This means that your filter will automatically backwash and rinse every 4 days or every 1200 gallons whichever comes first. This can be adjusted up to once every 7 days but backwash every 3 or 4 days is best for most home application.

Usage Logs: The following are diagnostic menus you can review later if you wish:

Daily Usage Log	Monthly Usage Log
Daily Peak Usage	Monthly Peak Usage
Weekly Usage Log	Review Regen. Times
Weekly Peak Usage	

Start the First Backwash

1. **After programming, repeat the Regeneration (backwash and rapid rinse cycle) step 3 to 4 or more times until the filtered water is clear. NOTE: the backwash water will still appear black even after several backwashes. Once filtered water is running clear the iron filter is ready to use.**
2. 2 Start with bypass valve in the **Bypass Position**.
3. 3 Press the **BACK/REGEN** button once to enter the backwashing cycle.
4. When the backwash icon is displayed, **slowly** open the bypass to a quarter position to make the water flow into the tank and out the backwash drain line to drain.

7500-Rev4 Pro-Ox Filter Installation & Startup Guide

5. After several minutes open bypass valve completely.
6. If possible, verify that the backwash flow corresponds with the size of your system below. You can easily run the drain hose to a bucket and using a watch verify the flow rate in gallons per minute. An adequate backwash is critical.

Make sure you have a minimum of these flow rates in gallons per minute. For example, if backwash water fills a 5-gallon bucket in 1 minute, you have 5 gallons per minute (GPM).

Find your size: 0.75 CF: 4.22 GPM 1.0 CF: 6.6 GPM 1.5 CF: 6.6 GPM 2.0 CF: 10 GPM 2.5 CF: 12 GPM.

7. After the backwash, the system will automatically go into the fast rinse stage. The control valve will return to service status (indicated by the up flowing meter on the left) after the backwash and rinse are complete.
8. **Repeat the Regeneration (backwash and rapid rinse cycle) step 3 to 4 or more times until the filtered water is clear. NOTE: the backwash water will still appear black even after several backwashes. Once filtered water is running clear the iron filter is ready to use.**

**CONGRATULATIONS,
YOU ARE DONE SETTING UP YOUR NEW SYSTEM!**

Advanced Programming Mode

Skip this for most applications as your filter system has already been set to correct modes.

1. Plug the RevV4 in and immediately press in sequence **MENU/CONFIRM**, then press **BACK/REGEN** button, then press the **DOWN** button to enter the Advanced Programming Mode.
2. Press **UP or DOWN** buttons or to select the menu item to be changed
3. Note: If valve locks while programming, unplug power supply and repeat step above.
4. Press **MENU/CONFIRM** to enter the main menu
5. Press the **UP or DOWN** buttons to highlight each option.
6. Press **MENU/CONFIRM** to enter highlighted option.
7. Press the **UP or DOWN** buttons to adjust the value.
8. Press the **MENU/CONFIRM** to accept the changes.
9. Press **BACK/REGEN** button to advance to service status

7500-Rev4 Pro-Ox Filter Installation & Startup Guide

Advanced Program Recommended Settings

Review Company Info	CWS 831-462-8500
Set Valve Model	62605
Set Language	English
Set Company Info	CWS 831-462-8500
Set Hour Mode	12 HR
Set Time of Day	Current time of day
Set Date	Current date
Set Program Type	Interlock
Set Regen Cycles	No. 1
Set Set Clear Data	Close
Set Regen Mode	A-07
Set Capacity	1200 Gals.
Set Regen Time	2:00 AM
Set Backwash Time	10 Minutes
Set B.S.R. Time	0
Set Fast Rinse Time	8
Set B.R. Time	0
Max Days for Regen.	4
Signal Output Mode	b-01
Set Service Alarm	Disabled
Review Regen Times	NA
Review Software Version	Ver. 5.0

7500-Rev4 Pro-Ox Filter Installation & Startup Guide

Maintenance

Every 5 to 10 years (in some cases it can last longer) remove control valve and empty the Pro-OX filter media and replace with new media.

There is no routine maintenance required for the control valve or filter media, other than making sure the system is set to backwash frequently enough to keep the filter media clean.

7500-Rev4 Pro-Ox Filter Installation & Startup Guide

7500-Rev4 Water Filters Limited Warranty

We warrant this water filter when installed according to factory recommendations, to be free from defects in materials and workmanship as follows:

Limited Warranty

This water conditioner unit is comprised of the finest industry components available. Each individual component used in the assembly of our equipment is covered by the original equipment manufacturer's warranty. All components, except those specifically listed below, are warranted for a period of one (1) year from date of installation to the original purchaser to be free of defects in materials and workmanship subject to the manufacturer's conditions and/or the conditions shown below.

Mineral Tanks

The fiberglass, polyglass or composite mineral tanks used in the assembly of this unit are warranted to be free of defects in materials and workmanship for a period of ten (10) years on 6" – 13" size tanks, and five (5) years on 14" and larger size tanks used for softener/filtration applications, subject to the manufacturer's conditions and/or the conditions shown below. **Warranty does not cover exposure to weather, freezing, fractures caused by external impact, or exposure to vacuum.**

Control Valves

The CWS control valve is warranted to be free of defects in materials and workmanship for a period of five (5) years.

Conditions

1. This warranty only covers water conditioners installed for residential use. Water conditioners installed for commercial or industrial applications are guaranteed for one (1) year from the date of installation.
2. Installation must be made in accordance with legal or local codes and manufacturer's recommendations.
3. Failure must not result from exposure to weather, rodents, misuse, alteration, fire, lightning, power surges or neglect.
4. Water pressure must not exceed 100 PSI and water temperature must not exceed 100 degrees.
5. Subject to the above terms and conditions we will replace and/or repair, at our option, any parts of the water conditioner found defective in materials and workmanship. Defective parts must be returned, freight pre-paid for repair or replacement.
6. **This warranty does not cover labor, shipping charges, damages caused by delays of consequential damages or other causes beyond our control. Warranty does not cover pipes, fixtures or appliances. Warranty extends to the actual water conditioner components only.**
7. This warranty is to the original purchaser and is not transferable to any subsequent owner(s).
8. No other guarantees or warranty, expressed or implied, is applicable to our product. No repair or replacement made under the terms of the warranty shall extend this warranty.
9. Any product returned to Clean Water Store without a valid return authorization number will be rejected. Any product found to be defective will, at the sole discretion of Clean Water Store be repaired or replaced. Clean Water Store is not responsible for shipping cost to the repair facility.