

The Definitive Guide To Well Water Treatment

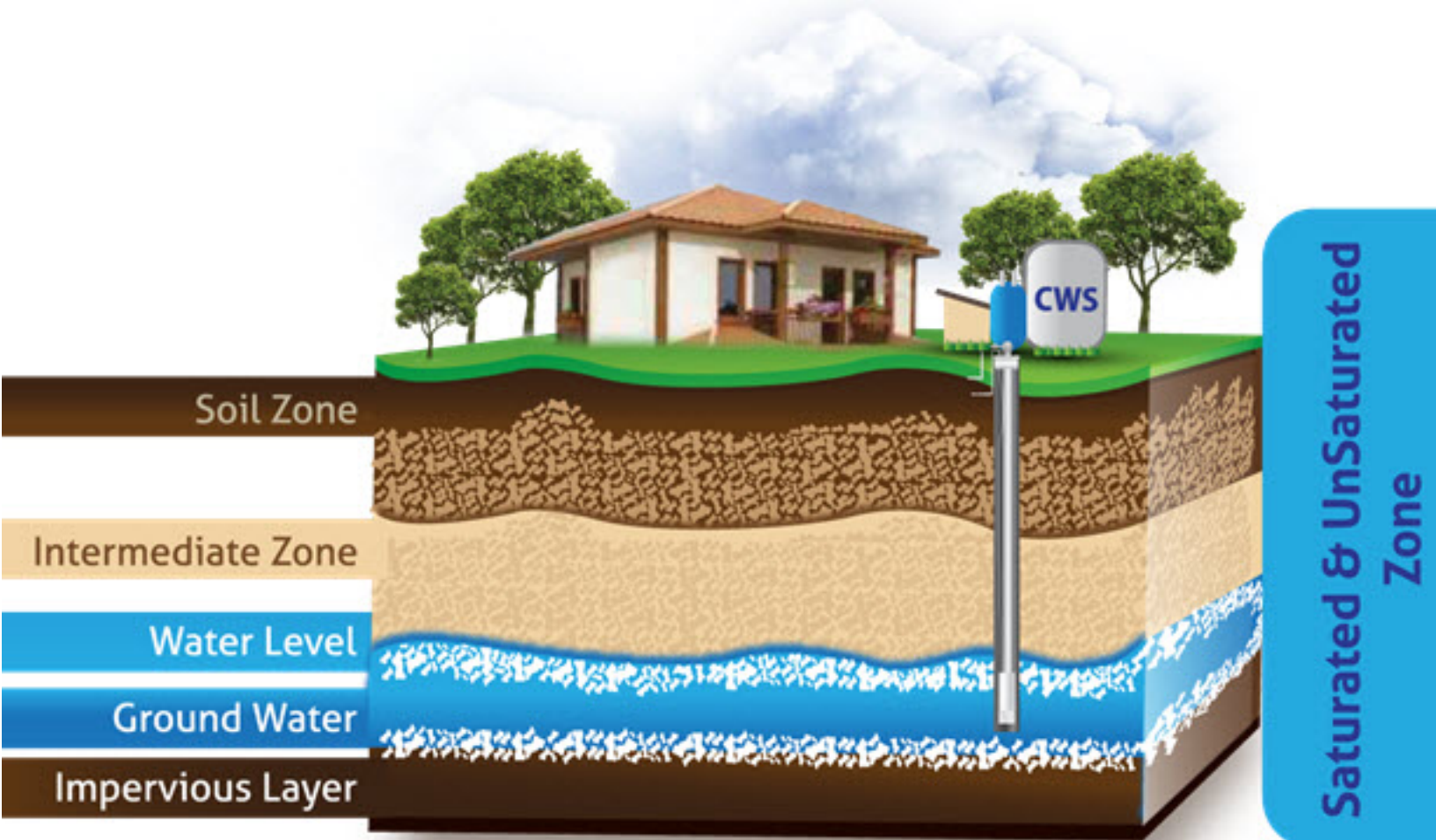

Effective Solutions for Problem Well Waters

www.cleanwaterstore.com

The Definitive Guide To Well Water Treatment

©2017 Clean Water Store

ISBN-10:0991231708

ISBN-13:978-0-9912317-0-6

No part of this eBook may be reproduced, distributed, or transmitted in any form or by any means, including photocopying, recording, or other electronic or mechanical methods, without the prior written permission of the author-publisher except in the case of brief quotations embodied in critical reviews and certain other non-commercial uses permitted by copyright law. For permission requests, email gb@cleanwaterstore.com

Welcome to The Definitive Guide To Well Water Treatment!

You now have at your fingertips a comprehensive resource guide for well water treatment. We hope you find this guide useful and look forward to your feedback and questions regarding well water treatment and water quality.

Our company [Clean Water Systems & Stores](#) has been providing solutions for tens of thousands of problem water wells since 1985. Over the years, we have been asked the same questions by homeowners, contractors, and well specialists dealing with tough problem water: “How can I determine which treatment solution is best for my problem?”

We created this guide to answer these questions in as simple a format as possible. Questions answered include:

- How do I know if I need water treatment? Where do I start?
- How can I know I am getting the best solution for the lowest cost?
- Which type of system should I buy for my water problem?
- Is it possible to get a filter or treatment system and install it myself?
- When should I hire a professional to do the installation and maintenance?

How to Use This Guide:

See the Table of Contents on page 4 and browse to find a water problem or type of issue you are interested in. We have included many tables and charts to help you identify the type and cause of your water quality problems.

At the end of the Guide you will see additional information on how your well works, plus various technical data and a comprehensive glossary.

If you have any questions about the material in this guide, please contact us!

Toll-free: 888-600-5426 Email: support@cleanwaterstore.com

Visit our Web Site www.CleanWaterStore.com

[Click here to see us on Facebook for daily updates and interesting facts!](#)



Clean Water Systems & Stores Inc.
2806-A Soquel Ave
Santa Cruz, CA 95062



Table of Contents

1. Well Water Treatment Cheat Sheet	7
2. The Basics	8
2.1 Test Your Water	8
2.2 Determine Your Well Pump Flow Rate	9
2.3 Perform a Toilet Tank Inspection	10
2.4 Check Your Water Heater	11
2.5 Check for Pipe Corrosion and Scale Build-up	12
2.6 Identify Pipe Sizes	12
3. Choose Your Water Treatment System	13
3.1 Hire a Contractor or Buy Yourself?	13
3.2 Where to Buy?	13
3.3 Which Type of Water Treatment System Is Best?	14
3.4 Avoid Pressure Drop Problems with Water Treatment Equipment	15
4. Best Practices for Installation	17
4.1 Hiring a Professional Versus Doing it Yourself	18
5. Treatment Solutions by Problem	19
6. Treatment Solutions by Stain Type	22
7. Odor Identification and Solutions	23
8. Color Identification & Treatment	24
9. Flakes, Particles, and Sediment	25
10. Fixture Problems Identification	26
11. Water & Health Problems	27
12. Iron Filtration	28
13. Iron Treatment Methods	30
13.1 Iron Filter Types and Operation	32
13.2 Oxidizing Iron Filter Comparison	34
14. Sediment Filtration	35
14.1 Multi-Media Filters for Sediment Removal	36

15. Water Softeners	37
16. No-Salt Water Conditioners	40
17. Reverse Osmosis	41
17.1 Under-Sink Reverse Osmosis Systems	42
17.2 Whole House Reverse Osmosis Systems	43
18. Ultrafiltration	46
19. Nitrate Removal	47
20. Tannin Removal	50
21. Neutralize Acid Water	51
21.1 Down-Flow Calcite Neutralizers	52
21.2 Up-Flow Calcite Neutralizers	53
21.3 Soda Ash Feeders	53
22. Eliminating Odors	55
23. Ozone Treatment	60
24. Ultraviolet Sterilizers	63
24.1 Factors Affecting UV Treatment	64
24.2 Routine Testing	65
24.3 Pretreatment System for Hard Water	65
24.4 Pretreatment for Sediment	66
24.5 Pretreatment for Iron in Well Water	67
24.6 Ultraviolet Sterilizers and Giardia	68
24.7 Microorganisms That Are Treated By UV	69
25. Chlorinators	71
25.1 How to Select and Size a Chlorinator Feed Pump	71
25.2 How Much Chlorine Should I Plan to Add?	71
25.3 How Do I Know What Size Chlorinator Pump to Install?	71
25.4 How to Size the Chlorine Metering Pump	72
26. Hydrogen Peroxide Systems	76

26.1	<i>How Hydrogen Peroxide Systems Work</i>	76
26.2	<i>Peroxide Installation</i>	78
26.3	<i>Selecting Hydrogen Peroxide Solution Strength & Pump Settings</i>	78
26.4	<i>How to Determine Peroxide Residual</i>	81
27.	Disinfection and Contact Time	82
28.	Shock Chlorination for Wells	86
28.1	<i>Shock Chlorination Using Chlorine Bleach:</i>	88
29.	How to Sanitize Pipes & Plumbing	92
29.1	<i>Shock-chlorination using the “Slug-in Method”:</i>	93
29.2	<i>Shock Chlorination Procedure by High-Pressure Metering Pump Injection:</i>	93
30.	Well Troubleshooting Guide	95
30.1	<i>Top 5 Warning Signs Your Water Well Is In Trouble</i>	95
30.2	<i>Causes of Sediment, Rust, Minerals or Odors</i>	98
30.3	<i>Dissolved Gasses or Air in Water</i>	100
30.4	<i>How Your Well Works</i>	101
31.	Case Studies	105
31.1	<i>After Neutralizer and Pro-OX Iron Filter: Crystal Clear and Tastes Like Spring Water.</i>	105
31.2	<i>Upgrading a System with the Greensand Iron Filter</i>	106
31.3	<i>Pro-Ox Iron Filter: “This new system is great! It was easy”</i>	108
31.4	<i>Pro-OX AIR Cures Rusty, Murky Water</i>	109
31.5	<i>Pro-OX Iron Filter Tackling the Worst Iron Problems</i>	110
31.6	<i>Bacteria Disinfection with the Wonder Light UV Sterilizer</i>	111
31.7	<i>Calcite Acid Neutralizer satisfaction.</i>	112
31.8	<i>Sediment Backwash Filter Working as planned.</i>	113
31.9	<i>Multiple Filter System Water Is “Right on the Money”</i>	114
32.	Glossary of Terms	115
33.	Additional Resources and Links:	138
	Technical and Product Questions Answered Fast	139

1. Well Water Treatment Cheat Sheet

Well Water Treatment Cheat Sheet and Check List



Avoid common well water problems by following this Check List.

Have questions? Call us at 888-600-5427 and speak with one of our WQA Certified Master Water Specialists.

Visit us online www.CleanWaterStore.com | Email us at info@cleanwaterstore.com

DO THE BASICS

- Test Water Chemistry
- Check Well Water Flow Rate
- Check for Odors
- Perform Toilet Flush Tank Check
- Water Heater Flush Check
- Check for Pipe Corrosion
- Determine Diameter of Pipe

DECIDE ON GOALS

- Treat water for one sink for drinking and/or
- Treat water for the entire home?
- Eliminate corrosion problems?
- Remove stains, sediment, odor?
- Improve water pressure?
- Disinfect water of bacteria?

INSTALLATION

- Buy direct and install yourself OR
- Buy direct and hire a plumber OR
- Buy from water treatment dealer
- Follow a checklist of best practices

QUALITY CONTROL

- Set up maintenance schedule
- Test well water annually for bacteria and nitrate
- Test treated water regularly and keep records

ENJOY HEALTHFUL HIGH-QUALITY WATER

- Water meets Health Dept Standards
- Great tasting, good for cooking
- No odor, stains, or sediment
- Non-corrosive to pipes and fixtures
- Free of bacteria, viruses or parasites
- High quality water for bathing and laundry

LEARN MORE ABOUT PRIVATE DRINKING WATER WELLS:

www.cleanwaterstore.com
<http://water.epa.gov/drink/info/well/index.cfm>

2. The Basics

- Test your water for general minerals, physical and coliform bacteria.
- If you live in an industrial or agricultural area, or near a gas station, also test for additional chemicals and heavy metals.
- Determine your well water flow rate in gallons per minute.
- Perform a toilet tank and water heater inspection.
- Check for odors in the water: odor in cold water? Hot water? Or both?
- Check for pipe corrosion and scale build up, unless the home is new.
- Identify the diameter of your main pipe coming in to home.
- Select a location for your water treatment system and determine space available.
- Select your water treatment system so it will not adversely affect your water pressure.
- Use best practices for installation and start-up.

2.1 Test Your Water

If you have never had your well water tested, or the well is new, or has recently been serviced, it's a good idea to have a complete general mineral, physical and bacteriological test done. This includes common minerals, salts, metals, and bacteria. It should always include a pH test, which tells you how acidic or alkaline the water is. With these results, you can determine if you need any type of water treatment, and what type of system to select, based on your water chemistry.

If you have well water and are experiencing staining, at a minimum make sure you test for pH, hardness, iron, manganese, and total dissolved solids, – not just iron and water hardness.

If you are trying to correct an aesthetic or corrosion-related problem, such as staining, pinhole leaks in pipes, or odors, then a general mineral analysis (which would include at minimum tests for iron, manganese, tannin, pH, total dissolved solids, hardness, and alkalinity) is recommended. In some cases, additional tests for tannins are recommended.

For health-related issues at a minimum include a test for total coliform, e-coli (fecal coliform). If infants and children will be drinking the water, a complete general, mineral, metals and bacteriological test is recommended.

See this link for more information about various types of well water testing kits and services:

<http://www.cleanwaterstore.com/well-water-test-kits.htm>

2.2 Determine Your Well Pump Flow Rate

Your well pump can pump water up to a certain maximum flow rate, in gallons per minute. For example, say you could fill a 5-gallon bucket in 1 minute. This is a flow rate of 5 gallons per minute or 5 GPM. If the water filled up a 5-gallon bucket in 30 seconds, the flow rate would 10 GPM. Knowing how many gallons per minute your water system can pump is critical to picking the right type of water treatment system, and it is easy to determine.

This method works for most well pumps. If your pump turns on at one pressure (typically 30 or 40 PSI) and off at a higher pressure (usually 50 or 60 PSI) this method will work for you.

It is easy! All you need is a 1 or 5-gallon bucket and a watch or clock. It takes just a few minutes:

1. Open any hose bib or faucet until pump turns on.
2. Close hose bib or faucet and let pump fill up pressure tank until it turns off.
3. Using a 1 or 5-gallon bucket, open faucet, collect & measure all water discharged until pump turns on.
4. When the pump turns on, immediately close faucet and start timing pump cycle*
5. When the pump turns off, record pump cycle time to refill pressure tank in seconds.
6. Divide the number of gallons collected in Step 3 by the number of seconds in Step 5.
7. Multiply the answer from Step 6 by 60.
8. The answer in Step 7 is the average pumping capacity of the pump in gallons per minute (GPM).

If you cannot tell when the pump is turning on and off, in other words, it is too silent and you cannot hear the well pump or pressure switch clicks, then do this:

Locate the pressure switch and remove the cover. **Warning: live voltage is under the pressure switch cover. DO NOT touch any of the live electrical terminals inside the pressure switch cover!**

Note that the pressure switch has four terminals; as the well pump runs, fills the pressure tank, and turns off, these points will open and close. When the points are closed together, you can tell the pump is running; when the points are open, the well pump is shut off.

Click this link to access our online [calculator](http://www.cleanwaterstore.com/technical/water-treatment-calculations/body_flow_rate.html) and make your calculations more quickly and easily:

http://www.cleanwaterstore.com/technical/water-treatment-calculations/body_flow_rate.html

Systems with Variable Speed (“Continuous Pressure Pumps”)

Some wells don't turn on at one pressure and off at another. These types of pumps are called “continuous pressure” or “variable speed” pumps, meaning that they run slow at first, and then faster as the pressure drops in the pipes. For continuous pressure systems, you need to consult with the pump installer or look at the pump's documentation to see what your flow rate is.

2.3 Perform a Toilet Tank Inspection

Check your toilet flush tank for staining and sediment:



Symptom	Cause	Solution
White scale on float	Calcium hardness	Water softener
	Total dissolved solids	Reverse osmosis
Tank sides are white, but black, rust or sand is laying on the bottom	Decaying galvanized pipes	Replace pipes; correct corrosiveness of water
	Sand, rust or sediment in well water	Sediment and/or iron filter
Blue stains	Acidic (low pH) water	Calcite neutralizer or soda ash feeder
Rust stains	Iron	Iron filter (Birm, MangOX, Greensand, Pyrolox)
Furry, stringy red growths	Iron (and/or other) bacteria	Chlorination, aeration, ozone injection, hydrogen peroxide, followed by filtration
Furry, stringy gray or black growths	Sulfur (or other) bacteria	Chlorination, aeration, ozone injection, hydrogen peroxide, followed by filtration
Frothy, with bubbles	Iron bacteria	Chlorination, aeration, ozone injection, hydrogen peroxide, followed by filtration
Brown stains	Iron and/or Manganese	Iron filter that removes manganese (MangOX, Pro-OX, Greensand, Pyrolox)
Black stains	Iron and/or Manganese	Iron filter that removes manganese (MangOX, Pro-OX, Greensand, Pyrolox)
	Ferric Sulfide (black rust)	Iron filter (Birm, Pro-OX, MangOX, Greensand, Pyrolox)
Pink stains	Airborne bacteria	Not water quality related; Clean with chlorine bleach

2.4 Check Your Water Heater

It is a good idea to periodically drain and flush your water heater. You will see that on the bottom of your water heater is a hose bib, or drain valve, which is a connection where you can attach a garden hose. Simply attach a garden hose, and fill up a white 5-gallon bucket.

If the water is clean, your water heater may not have any sediment in it, or it could have sediment from calcium hardness that has solidified. If you see sand or black sediment, or white chips, or blue chips, this can indicate your water heater dip tube has deteriorated, and/or the water heater lining is going bad. If you get a lot of rust or brown looking deposits, and your pipes are not iron piping, then the well water likely contains high levels of iron or manganese.

Before draining your water heater, you may wish to buy a brass hose bib cap. These are available at all hardware stores, are inexpensive, and will allow you to cap off the drain valve on your water in the event it will not shut off once you try to close it after draining.

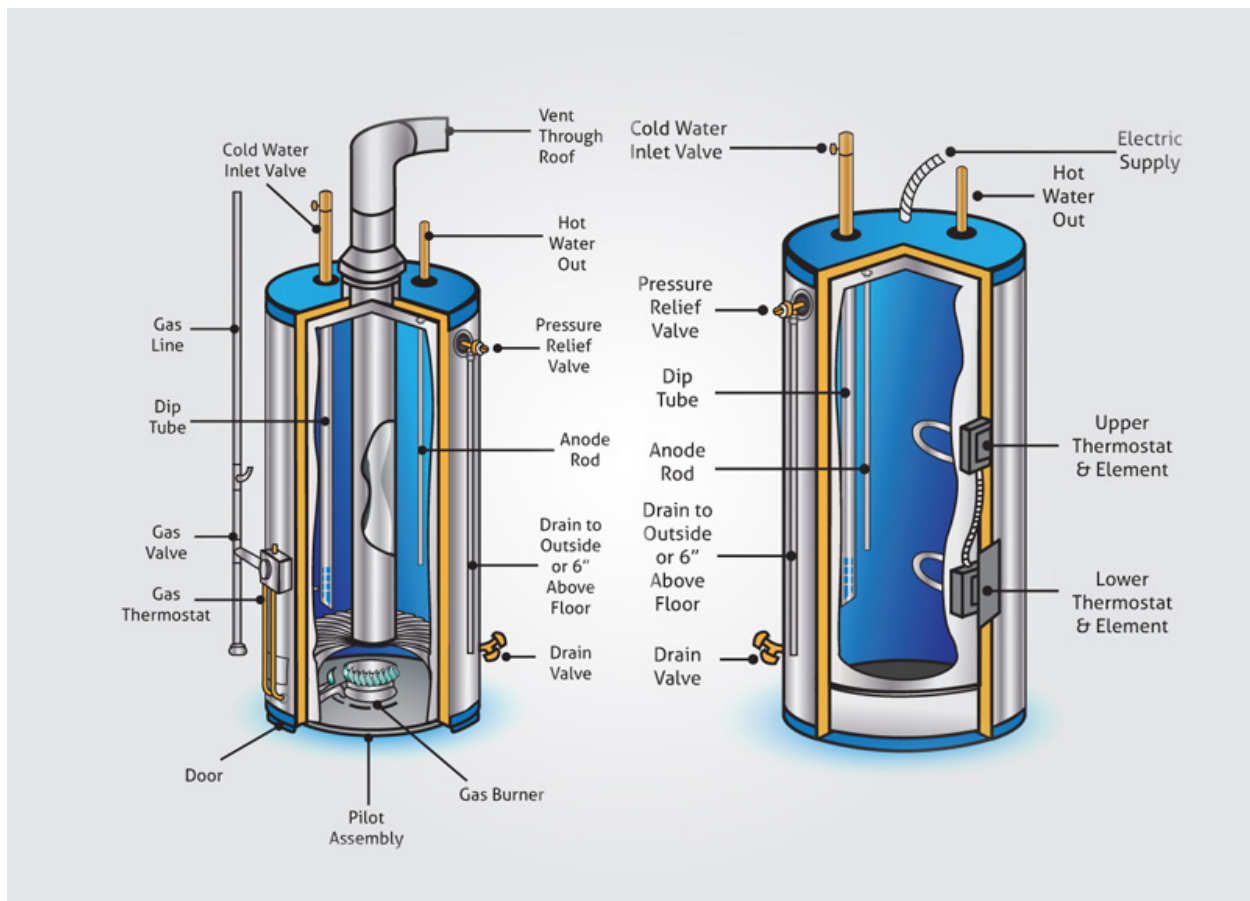

2.5 Check for Pipe Corrosion and Scale Build-up

Unless your home is new, it is important to check for pipe corrosion and scale build-up in the piping:

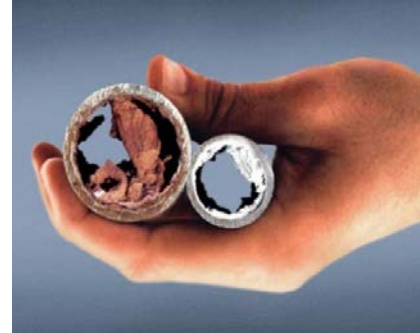

- Check for signs of blue stains in fixtures or toilet tanks that can indicate copper corrosion, and/or test water for copper.
- If you have galvanized iron pipe, look for signs of rust and scale in the toilet flush tank.
- If possible, inspect the exterior of pipes and valves, to see if you see any signs of pinhole leaks or corrosion by-products which can be crusty, bluish, white or salty looking or rusty.
- If you are having any plumbing work done on your house, inspect any sections of the pipes that have been cut to see if there is any scale build-up or signs of corrosion.

2.6 Identify Pipe Sizes

It is useful to know the size of your incoming pipes. For instance, say you decide you want to install an iron filter system for your house. They come in different pipe sizes, such as $\frac{3}{4}$ " pipe, 1" pipe etc. Generally, you want to make certain you get a filter or water treatment system that will not restrict the water flow or pressure, so if you have a 1" pipe, you would want an iron filter that has 1" pipe connectors. Knowing what size piping you have solves this problem.

It is easy to check the size of your pipes. First, check on the pipe itself, often it will be labeled or written on the side. If not, the string method which measures the circumference is probably the best way to determine your pipe size. Circumference is the distance it takes to go around the pipe once.

Remove any insulation from the pipe. Using a piece of string about 6" long (or a cloth tape measure) wrap the string around the pipe once and measure to the nearest $\frac{1}{8}$ of an inch... Once you have found the circumference, use the chart below to find your pipe or tube size.

Copper Pipe or PEX tubing

2.75" (70mm) = $\frac{3}{4}$ " pipe
3.53" (90mm) = 1" pipe
4.32" (110mm) = 1 $\frac{1}{4}$ " pipe
5.10" (130mm) = 1 $\frac{1}{2}$ " pipe

Flexible (usually black) Polyethylene Pipe

2.96-3.33" (75-85mm) = $\frac{3}{4}$ " pipe
3.74-4.24" (95-108mm) = 1" pipe
4.90-5.57" (124-141mm) = 1 $\frac{1}{4}$ " pipe
5.70-6.28" (145-160mm) = 1 $\frac{1}{2}$ " pipe

Steel Pipe or PVC Plastic Pipe

3.25" (83mm) = $\frac{3}{4}$ " pipe
4.00" (102mm) = 1" pipe
5.00" (127mm) = 1 $\frac{1}{4}$ " pipe
6.00" (152mm) = 1 $\frac{1}{2}$ " pipe

3. Choose Your Water Treatment System

Now that you know your water chemistry, flow rate, and pipe size, you can select your treatment system. You could choose the purchase based solely on the price, but there are other considerations as well.

3.1 Hire a Contractor or Buy Yourself?

Start by consulting the Water Quality Association website www.wqa.org for help in locating a Certified Water Treatment Professional in your area. WQA certified professionals pass rigorous certification exams and conform to a code of ethics.

Recommendations and quotes from local water treatment companies usually include installation, as most water treatment dealers and contractors prefer to install the system for you and offer you routine service for an additional cost. See the chapter: “Hiring a Professional Versus Doing it Yourself.”

There can be advantages to hiring a qualified local water treatment contractor if they are certified and bonded and have the experience to solve your water problem. If you plan to save money on the installation and equipment costs and do it yourself, you can buy it yourself and hire a plumber to install it, or install it yourself.

3.2 Where to Buy?

Online websites such as www.cleanwaterstore.com and hundreds of others allow you to compare costs and features of various systems. If you do basic plumbing or are willing to hire a plumber you can often save hundreds of dollars and end up with an excellent system.

Many hardware stores sell water treatment equipment, as do big box stores like Home Depot, Lowes, Sears, etc. Often these stores have limited selection and cannot treat complex or difficult water problems, but they can be a quick and easy solution for simple water problems for small homes and businesses.

Plumbers and plumbing wholesale distributors often sell a limited selection of water treatment equipment direct to the public.

Water treatment dealers will sometimes sell their equipment at a discount but typically they prefer to offer a total package of installation and service.

3.3 Which Type of Water Treatment System Is Best?

After you have educated yourself about your water chemistry and flow rate, you can use the charts in this Guide to determine which system will work best for you. If you have any questions and want to get an expert opinion, consult a technician that has been certified by the Water Quality Association at www.wqa.org.

Select a Location for Your Water Treatment System

Most automatic water treatment systems require some the following considerations:

- System must connect to the main line coming in, or connects to and from this incoming pipe.
- Often the water treatment system for the house will bypass outside garden water.
- Determine the height, width and floor space required for each piece of equipment.

Most automatic filter systems have some type of backwash or drain water, and need to be connected to a drain. If your home is on a septic tank, this is usually the best place to discharge the backwash waste water. In some cases, a separate French drain (a drainage trench with gravel is used) is best, depending on local codes and soil conditions. If the backwash water contains no chemicals or salts, it can be discharged to a garden or wooded area and used for irrigation, but local building and health codes may prevent this option.

Most automatic filter systems require electrical power, although most use very little actual power. For instance, a typical iron filter will need to be plugged into a 120v outlet, but only use 0.25 to 0.5 amp or about 30 to 60 watts of power at most.

Keep the water treatment equipment (and your pump and pressure tank) from being exposed to excessive heat or freezing. If your system will be housed in a small area (e.g. a shed), make sure the area is well ventilated to avoid overheating. Likewise, protect all equipment from freezing.

If you live in a seismic zone, strap your system to a wall to prevent damage from earthquakes.

It is best to prevent sunlight from directly shining on the equipment to prevent the sun from warming up the filter tanks or water softener.

Chlorinator, contact tank, backwash sediment filter, carbon backwash filter and water softener installation in a customer's basement.



3.4 Avoid Pressure Drop Problems with Water Treatment Equipment

Understand how your well pump and pressure tank works. There is a pressure switch that measures the amount of water pressure in PSI (pounds per square inch) in your household plumbing. As you use water, water flows from your pressure tank, and as the pressure drops to a preset level, the pressure switch turns the well pump on.

Unless you have a constant-pressure type of pump that maintains a constant pressure, most pressure switches are set to turn on at one pressure, typically 30 to 50 PSI, and off at a higher pressure, typically 20 PSI over the lower pressure.

If you want higher pressure, you or your well service company could theoretically adjust your pressure switch to turn off at a higher pressure. However, in some cases, the pump cannot deliver a higher pressure. For instance, say you want more water pressure, and your well pump turns on at 20 and off at 40 PSI. You could probably adjust it so it turned on at 30 or 40 and off at 50 or 70 PSI, but if your well pump cannot build up enough pressure to reach the new higher cut-off point, it will just keep running and not turn off, and eventually be damaged.

Note that if you did adjust your incoming pressure, you would need to adjust the static air in your pressure tank, when there is no water pressure in the system. This is done by locating the air valve for the tank, and using a pressure gauge to test the air pressure. (Do this only when the tank has no water pressure in it and is drained.) Adjust the air pressure so it is 2 to 4 PSI less than the lower cut-in pressure the pressure switch is adjusted to.

You could have high water pressure and still have poor water flow. As an example, your well may produce plenty of good flow and pressure, but the flow is restricted by a small cartridge filter, or the pipes are full of scale or iron deposits. Even though the well can produce good flow and pressure, you can still experience poor water pressure and flow inside the home.

This same phenomenon occurs when the piping is undersized, there are stuck or corroded valves, scale has built-up in the piping reducing pipes that are 1" down to ½" interior diameter, etc. It is important therefore to select a water treatment system that will not restrict the flow below what you need.

Cartridge filters require regular cleaning or maintenance and will restrict the flow and lower the water pressure in the house, particularly if not sized correctly or maintained routinely. If the budget allows, it is generally better to use a self-cleaning backwashing filter system which after backwashing, to restore the filter system to its original state and prevent a pressure drop through the filter system.

Automatic backwash filter systems require a minimum flow rate to backwash properly. For instance, say you need an iron filter, and your well water flow rate is 8 gallons per minute. You decide you want to get the largest system you can afford and the one you select has a backwash flow rate requirement of 10 gallons per minute.

Within a few months this type of iron filter will become fouled and fail to remove the iron correctly, because it needs 10 gallons per minute but your well water flows at 8 gallons per minute. If you select an iron filter that works with 8 gallons per minute or less, the filter will backwash with no problems and cause no maintenance problems due to low backwash flow rate.

In some cases, you could use this larger filter: for example, a large enough pressure tank, or two pressure tanks in series, could provide the higher flow rate for a few minutes before the well water flow rate kicked in.

Pressure tanks will store a small amount of water to provide a slightly higher flow rate for a few minutes. For example, an 85-gallon pressure tank will have a drawdown (meaning the amount of water that comes out of the pressure tank under pressure, before the well pump turns back on) of 20 to 30 gallons. So, for instance, you would enjoy 10 gallons per minute for 3 minutes based on the pressure tank alone.

Typical Water-Well Sediment Backwash Filtration System

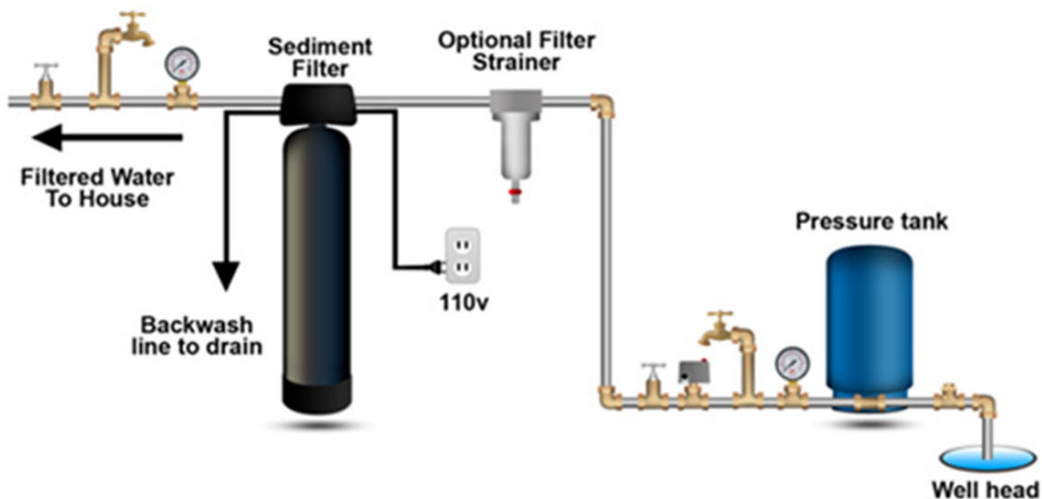

4. Best Practices for Installation

- If you are installing your own water treatment system, review your packing list and make sure you have received all the parts for your new water system before beginning installation.
- If you are going to be turning off the water to the house and you have an electric water heater, shut off the power to the water heater before beginning installation.
- Pick a suitable location for your filter system on a dry, level spot where it won't be exposed to freezing temperatures. A minimum of 20 PSI is required. Maximum pressure is 90 PSI.
- Get all of your plumbing parts together before beginning installation.
- After the system is installed and running, your water may be discolored, or full of sediment or rust, particularly you have older or corroded piping. Typically this clears up over a few hours, but can last for days or weeks if your piping is severely corroded.
- Automatic filters are always installed after the pressure tank, never before it.
- Make sure to connect the inlet pipe to the inlet on your automatic treatment system, and the outlet pipe to the outlet connector on the system.
- Make sure there is a working gate or ball valve before the treatment system and also one after. A hose bib (a type of faucet that a garden hose can be connected to) is recommended after the filter before the second ball valve. This makes it easy to rinse your backwashing filter or softener on start-up and gives you a place to test the water before it enters your house.
- Note that the backwash water flows out of the treatment under pressure, and can run up above the treatment system and into a drain. It does not have to drain down, as the filter backwashes under line pressure from your well pump. Follow local plumbing codes. After installation, make sure to check the backwash flow rate in gallons per minute to verify system backwash is correct. This is a simple matter of filling a 5-gallon bucket from the backwash water and timing it.
- Follow manufacturer's start-up and maintenance procedures. After installation, pressure test and check for leaks. Flush household pipes with faucet aerators to remove scale and sediment. Check backwash flow rate of filters to confirm they are backwashing to specification. Test water to determine after-treatment water quality.

4.1 Hiring a Professional Versus Doing it Yourself

There are some advantages to installing your own water treatment system:

- Much lower price for equipment
- Save installation costs by doing it yourself, even if you hire a plumber to do the installation.
- You don't need to pay for expensive service calls in the future, saving time and money.
- If your local water treatment dealer is not experienced in your water problem or issue, you can end up with a better-quality project than if you had it installed by a water treatment dealer.
- You become knowledgeable about your own water treatment system and can easily service it.

There can be disadvantages as well and some situations where you may want a local professional:

- You may encounter problems if you aren't familiar with basic home plumbing and don't want to hire a plumber.
- You must be willing to do the basic service involved. This can take some time, although home water treatment systems rarely require more than a once-per-month check, and most only need service every 3 to 12 months.
- If you don't live at the home (for instance if you are renting) you may need service calls that you cannot handle due to time constraints, particularly if the property is in a different town or state.
- Your water may contain serious health-related contaminants such as heavy metals, or agricultural contaminants such as pesticides or herbicides. If the system fails for any reason, your health can be compromised.
- If the well water system serves a regulated small community, or commercial establishment such as a day-care, service station, nursing home, or school, a state licensed water treatment operator is required.

What to look for in a water treatment professional:

Make sure the system comes with a money back guarantee so that if it doesn't work, you can return it within a reasonable period, typically 6 months.

Make sure the company is a member of the Water Quality Association and their technicians are certified Water Treatment Professionals. See www.wqa.org for a list of local professionals.

If you are going to hire a local company to do the installation, be sure the company is licensed to do the installations (if contractor's licenses are required in your state) and that the company has liability and workers compensation insurance.

Check references of other installations in your area.

5. Treatment Solutions by Problem

Water Problem	Symptom	Treatment Remedy
Alkaline Water pH > 8.5	Slippery feel; soda taste; deposits;	Inject acetic acid (white vinegar); or reverse osmosis
Acidic Water pH < 5.0	Corrosion of pipe, fixtures and appliances	Inject soda ash or sodium hydroxide
Acidic Water pH < 6.0	Corrosion of pipe, fixtures and appliances	Calcite blend neutralizer filter with 90% calcite 10% "Corosex" or "FloMag.
Acidic Water pH < 7.0	Corrosion of pipe, fixtures and appliances	Calcite neutralizer filter
Arsenic	Adverse health effects, poisonous over 10 parts per billion	Arsenic filter; or chlorination followed by greensand filtration
Bacteria - Heterotrophic	Heterotrophic plate count bacteria have no health effects; it is an analytic method used to measure the variety of bacteria that are common in water. The lower the concentration of bacteria in drinking water, the better maintained the water system is.	Disinfection with chlorine, hydrogen peroxide, ultraviolet light or ozone
Bacteria - Coliform	Possible negative health effects, indicates well is under the influence of surface water so risk of parasites and harmful bacteria possible	Disinfection with chlorine, ultraviolet light or ozone
Bacteria - E. Coli (fecal)	Adverse health effects, indicates well is contaminated by septic tanks or other run-off from sewage or animal activity	Disinfection with chlorine, ultraviolet light or ozone
Chlorine	Tastes and odors, can irritate skin, dry hair	Carbon filtration; or KDF media filtration
Copper	Adverse health effects at higher levels over 1 mg/L; usually indicates corrosion of copper pipes;	Correct corrosion problem using neutralizer above; in some cases, a phosphate feeder can be used to coat the pipes; if copper is naturally occurring, use ion-exchange system.
Fluoride	Tooth discoloration, adverse health effects at higher concentration over 2.0 mg/L	Reverse osmosis; or activated alumina filter

Gasses	Air in pipes, bubbles in water, possible dangerous or negative health effects if gas is methane or carbon dioxide	Off-gas into an open storage tank, ventilate well and use caution in treating this problem; methane is flammable
Hardness (calcium)	Scale in pipes, white deposits on fixtures and surfaces; soap forms scum and does not dissolve properly; dry skin and hair; over 100 mg/L is considered hard.	Water softener; phosphate feeder.
Hydrogen Sulfide Odors	Rotten-egg odors; can cause corrosion of brass and other metals; black discoloration in fixtures and appliances; possible adverse health effects at low concentrations;	Chlorination, aeration, ozone injection, hydrogen peroxide, followed by filtration; in some cases greensand filtration and/or catalytic activated carbon be used
Iron Bacteria	Rust and red color slime in toilets and fixtures; can cause odor problems and slime up water heaters, toilet tanks and ruin laundry; maximum iron level recommended is 0.3 PPM	Chlorination, or ozone injection, or hydrogen peroxide, followed by filtration
Iron - Colloidal	Discolors water, causes stain in laundry and fixtures, bad tastes and odors. Very fine cloudy substance in water that does not easily settle out and is difficult to filter	Chlorination, or ozone injection, or hydrogen peroxide, followed by activated carbon filtration; OR ultra-filtration membrane; OR flocculent injection, coagulation and filtration using chemicals and sand filtration
Iron - Dissolved (Clear)	Clear when water is first drawn, water then turns orange or rusty after being exposed to air; causes build-up in pipes and fixtures, ruined laundry and water heater problems; maximum iron level recommended is 0.3 mg/L	Iron filter such as Greensand, Pro-OX, MangOX, Pyrolox, and Birm; in some cases, a water softener can be used if total dissolved solids are less than 500 PPM and the water hardness is less than 200 PPM and the pH is less than 7.0.
Iron - Oxidized (Rust)	Rust in water, is orange or brown in color. Bad tastes and odors, stains laundry and fixtures over 0.3 PPM	Iron filter such as Greensand, Pro-OX, MangOX, Pyrolox, Birm;
Manganese	Often found with iron, and causes brown, black and/or tea-colored staining, and imparts asphaltic and oily tastes, above .05 PPM.	Greensand, Pro-OX, MangOX, or Pyrolox; Or Chlorination, aeration, ozone injection, followed by filtration
Nitrate	Not usually naturally occurring is caused by run-off from chemical fertilizers, septic system discharge and livestock waste. Health problems if ingested over 10 PPM, especially for infants and pregnant women.	Anion exchange system with nitrate specific resin; Or reverse osmosis in some applications

Odors - Other	Variety of causes: metals in water, bacteria, algae, and gasses. Can have adverse health effects.	Chlorination, or ozone injection, or hydrogen peroxide, followed by activated carbon filtration
Radon	Radioactive element dissolved as a gas can increase risk of cancer	Air-stripping system with vents to the outside
Sand	Sand and grit in pipes and fixtures	Centrifugal sand separator, or sand filter screen, or cartridge filter; or sand trap settling tank
Sediment	Sediment in pipes and fixtures, clogged aerators and screens, washing machine slow to fill.	Backwash sediment filter, and/or cartridge filters
Sulfate	Salty tastes over 250 mg/L; can cause stomach upset and diarrhea at higher concentration if magnesium is also present in the water.	Reverse osmosis
Surface Water	Risk of bacteria, viruses and parasites; can be discolored and high in turbidity	Chlorination, or ozone injection, or hydrogen peroxide, followed by activated carbon filtration, sediment filtration, and ultra-filtration membrane; in some cases, the ultra-filter can be used with a simple pre-filter.
Tannin	Discolored water, color of tea, yellow or brown; can stain laundry and make disinfection more difficult if bacteria are present; over 2.0 mg/L can be a problem for some iron filters.	Anion exchange system with tannin resin
Total Dissolved Solids	At higher levels over 1000 PPM can cause corrosion, bad tastes and leave a white film and surfaces; glass can be etched; accelerates corrosion of pipes and fixtures.	Reverse osmosis
Turbidity	Turbidity is a measure of the cloudiness of water. Higher turbidity levels are often associated with higher levels of disease-causing microorganisms such as viruses, parasites and some bacteria.	Coagulation with alum or polymer followed by filtration. Chlorination, or ozone injection, or hydrogen peroxide, followed by activated carbon filtration, sediment filtration, and ultra-filtration membrane;

6. Treatment Solutions by Stain Type

Observe any stains on fixtures and check to see what the possible causes are:

Stain	Cause	Possible Remedy
Black stains	Manganese	Iron filter that removes manganese (Pro-OX, MangOX, Greensand, Pyrolox)
Black stains	Ferric Sulfide (black rust)	Iron filter (Birm, Pro-OX, MangOX, Greensand, Pyrolox); chlorination followed by filtration
Blue stains	Acidic (low pH) water	Calcite neutralizer or soda ash feeder
Brown stains	Manganese	Iron filter that removes manganese (Pro-OX, MangOX, Greensand, Pyrolox)
Laundry stains black	Manganese	Iron filter that removes manganese (Pro-OX, MangOX, Greensand, Pyrolox)
Laundry stains brown or black	Ferric sulfide	Iron filter (Birm, Pro-OX, MangOX, Greensand, Pyrolox)
Laundry stains rust	Iron	Iron filter (Birm, Pro-OX, MangOX, Greensand, Pyrolox)
Pink stains	Airborne bacteria (not water related)	Clean fixture with chlorine bleach
Rust stains	Iron	Iron filter (Birm, Pro-OX, MangOX, Greensand, Pyrolox); Or Water softener for low concentrations of dissolved iron
Slimy rust stains	Iron bacteria	Chlorination, aeration, ozone injection, hydrogen peroxide, followed by filtration
White film	Total dissolved solids (salts)	Reverse osmosis
White stains	Calcium hardness	Water softener

7. Odor Identification and Solutions

Does the cold well water have an odor right out of the well, from an outside hose bib?

If there is an odor to the water, do all the taps in the home have the odor? Do some taps in the house (such as upstairs, or from a bathroom or fixture) have greater odor than others?

Does the hot water have the odor only, with the cold water having no odor?

Odors	Source	Possible Remedy
Asphalt or oily odor	Manganese	Iron filter that removes manganese (Pro-OX, MangOX, Greensand, Pyrolox)
Oily odor	Petroleum	Oil removal media with activated carbon (OilSorb); but in some cases it's better to develop a new water source
Cucumber odor	Iron or sulfate reducing bacteria	Disinfection with chlorine or ozone or peroxide, followed by filtration
Earthy or grass odor	Geosmin	Produced by actinomycetes, blue-green algae, and green algae.
Garlic odor or taste	Methane gas	Off-gas into an open storage tank, ventilate well and use caution in treating this problem; methane is flammable
Metallic odor	Iron, manganese, or copper	Determine cause by testing water
Pond or Algae odors	Bacteria, organic matter	Disinfection with chlorine or ozone , followed by filtration
"Rotten egg" odor	Hydrogen sulfide gas	Chlorination, aeration, ozone injection, hydrogen peroxide, followed by filtration
	Sulfur bacteria	Chlorination, aeration, ozone injection, hydrogen peroxide, followed by filtration
Sewage odor	Leaking septic tank	Repair or re-locate septic tank or well
	Bacteria	Disinfection with chlorine or ozone or peroxide, followed by filtration; or repair or re-locate septic tank or well

8. Color Identification & Treatment

Color	Cause	Possible Remedy
Blue color	Copper corrosion	Calcite neutralizer or soda ash feeder to neutralize pH
Brown or rust color	Iron and/or manganese	Iron filter (Birm, Pro-OX, MangOX, Greensand, Pyrolox)
Cloudy or milky color	Colloidal clay & suspended particles	Flocculation and filtration; ultra-filtration
Cloudy water	Bacteria	Disinfection with chlorine or ozone or peroxide, followed by filtration
Dark color	Organic matter	Tannin filter
Pink color	Potassium permanganate	Water has too much chlorine, ozone or peroxide and the manganese has been converted to potassium permanganate.
Tea color	Tannins, humic acids	Tannin filter or injection with chlorine or ozone or peroxide, followed by filtration
White color	Air or gas in water	Off-gas into an open storage tank, or repair air leak
Yellow color	Colloidal iron	Tannin filter; or inject chlorine and filter with activated carbon

9. Flakes, Particles, and Sediment

Flakes or Particles	Cause	Possible Remedy
Black flakes, sand or grit	Lining of water heater deteriorating	Replace water heater
Black grit or particles	Corrosion from lining of galvanized pipe	Replace galvanized pipe with copper or plastic pipe
Blue flakes	Water heater dip tube deteriorating	Replace water heater
Blue or green flakes	Copper-stained calcium particles	Check for corrosion and pH
Dirt color sediment	Sediment from well water	Sediment backwash filter, or cartridge type filter
Gray sand or grit	Water heater liner deteriorating	Replace water heater
Red, yellow or orange beads	Water softener resin from broken water softener	Repair or replace water softener
Rust flakes	Rust and iron from well water	Sediment backwash filter, and/or iron filter
Rust or orange flakes	Rust from corroded pipes	Sediment backwash filter, or cartridge type filter
Sand or grit	Sand from well	Sand separator or filter
White or tan flakes	Clay or calcium particles from well water	Sediment filter
White plastic flakes	Water heater dip tube deteriorating	Replace water heater

10. Fixture Problems Identification

Fixture or other Physical Problems	Cause	Possible Remedy
Air or gas spitting from fixtures, or cloudy water	Air being sucked into pump or piping system	Repair pump or piping
Air or gas spitting from fixtures, or cloudy water	Carbon dioxide gas	Off-gas into an open storage tank, ventilate well and use caution in treating this problem
Air or gas spitting from fixtures, or cloudy water that clears	Methane gas	Off-gas into an open storage tank, ventilate well and use caution in treating this problem; methane is flammable
Landscape dying	High total dissolved solids	Reverse osmosis
Landscape dying	High boron	Reverse osmosis
Landscape dying	pH too high	Inject acetic acid (white vinegar)
Low water pressure	Clogged pipes and fixtures	Replace pipe or fixtures
Low water pressure	Worn out pump	Replace or service pump
Low water pressure	Stuck check valve	Replace check valve
Low water pressure	Stuck or partially closed gate valve	Replace gate valves
Soap scum in shower	Manganese or ferric sulfide (black rust)	Iron filter that removes manganese (Birm, Pro-OX, MangOX, Greensand, Pyrolox)
Soap won't dissolve	Calcium hardness	Water softener
Washing machine slow filling	Sediment	Clean washer hose screen; install sediment filter
Water heater noises	Water heater is built up with hardness or sediment	Replace water heater
White scale	Calcium hardness	Water softener
White spots	Total dissolved solids	Reverse osmosis

11. Water & Health Problems

Problem	Cause	Possible Remedy
Dry skin or hair	Calcium hardness	Water softener
Dry or irritated skin	Total dissolved solids (salts)	Reverse osmosis
Diarrhea	Bacteria, viruses, or parasite	Disinfection with chlorine or ozone, or ultraviolet sterilizer; use 1 micron absolute filter for parasite removal
Skin rashes	pH of water too high or too low	Neutralizer or acid injection
	Total dissolved solids (salts)	Reverse osmosis
	Chlorine	Carbon filtration
	Other causes - (chemicals, metals)	Investigate causes and analyze water
Stomach upset	Bacteria, viruses, or parasites	Disinfection with chlorine or ozone or ultraviolet sterilizer; use 1 micron absolute filter for parasite removal
	Manganese	Iron filter that removes manganese (Filox, Pro-OX, MangOX, Greensand, Pyrolox)
	Sulfate	Reverse osmosis
	Other causes	Investigate causes and analyze water
Stomach ulcers	H. pylori bacteria	Disinfection with chlorine or ozone or use ultraviolet sterilizer;
Teeth discoloration	Fluoride	Filter fluoride with reverse osmosis or activated alumina

*** NOTE: If you suspect you are suffering from health problems due to contaminated well water, you should get the water analyzed by an independent state-certified and licensed water laboratory.**

12. Iron Filtration

Iron is one of the earth's most plentiful resources, making up at least five percent of the earth's crust. Iron is considered a secondary or "aesthetic" contaminant, not a health threat. The maximum amount recommended in water is 0.3 mg/L, or .03 parts per million (PPM).

When the level of iron in water exceeds the 0.3 mg/l limit, the water may have a red, brown, or yellow color and stain laundry and fixtures. The water may also have a metallic taste and an offensive odor. Water system piping and fixtures can become restricted or clogged.

There are four main types of iron or conditions in which iron is found in well-water:

1. Soluble "Clear Water" Iron
2. Insoluble Oxidized "Red Water" Iron
3. Organic Iron
4. Iron Bacteria

Clear Water Iron

Water with clear water iron looks clear at first, and then develops color or rust after being exposed to air or other oxidants such as chlorine. If the iron level is less than 5.0 PPM and the water has not been exposed to air, a water softener can often be used to remove the iron. Softeners add sodium to the water and require the use of salt.

A more common way to treat clear water iron is with an Oxidizing Iron Filter. Oxidizing Iron Filters use air, chlorine, potassium permanganate, or ozone to oxidize the iron to a soluble type iron, and then filter it out with various types of iron filter media. Oxidizing Iron Filters use a type of powerful media made from manganese oxide to change the iron from clear to insoluble. If the iron level is less than 5.0 PPM, there is sometimes enough naturally dissolved oxygen present in the water to allow the iron filter to work without any additional air or chemical oxidizers.

Red Water Iron

If all the iron in the water is found as red water iron, then a cartridge type filter or a backwashing sand filter can remove it. However, it is more common that even though the water contains red water iron, it also contains some clear water iron and since a filter cartridge or sand filter cannot remove clear water iron, staining is still a problem. Oxidizing Iron Filters remove both red water and clear water iron.

Organic Iron

Organic iron and tannins present special water treatment challenges. Tannins are natural organics produced by vegetation which stain water a tea-color. Organic iron is a compound formed from an organic acid such as tannin or humic acids and iron. Organic iron and tannins can occur in very shallow wells, or wells being affected by surface water.

Organic iron and tannins can slow or prevent iron oxidation, so water softeners, aeration systems, and iron filters may not work well. An oxidizer such as chlorine combined with activated carbon and an oxidizing iron filter can be used for tannin removal. If the iron level is low but the water has a tea color from tannins, a special type of tannin filter system is used, which regenerates with salt like a water softener but does not soften the water.

Iron Bacteria

Iron bacteria are organisms that consume iron to survive and, in the process, produce deposits of iron, and a red or brown slime called a “biofilm.” The organisms are not harmful to humans, but can make an iron problem much worse. Indications of iron bacteria include a red or yellow color to the water, slime on the inner walls of the toilet tank, and/or odors that resemble fuel oil, cucumber or sewage.

These organisms naturally occur in shallow soils and groundwater, and they may be introduced into a well or water system when it is constructed or repaired. Iron bacteria is treated by shocking the well with chlorine on a regular basis and/or installing a chlorinator, or an ozone or hydrogen peroxide system with contact tank to kill all iron bacteria and oxidize the iron, prior to an automatic iron filtration system.

In addition to the four main types of iron or conditions in which iron is found in well water, there are other conditions which should be considered when deciding what kind of system to install:

pH - pH refers to the relative acidic or alkaline nature of the water. The pH scale is from 1 to 14. A pH of 7 is neutral; less than 7.0 is considered ‘acidic’ and higher than 7.0 is considered ‘alkaline’. Iron filters operate within a certain pH range, usually 6.5 – 8.5. **Ideally the pH should be 6.8 to 7.4 for best results with iron filtration.** If pH is acidic, correct pH to 6.8 to 7.4 using a soda ash feeder or calcite neutralizer. The exception to this is when you are using ion-exchange resin (i.e. water softeners) to remove iron.

Hydrogen Sulfide (“Rotten Egg Odor”)- Hydrogen sulfide (H₂S) is an odorous gas present in many well waters. The gas imparts a very strong sulfur or “rotten egg” odor to the water. H₂S can be present in the water coming directly from the well, and/or be present in the hot water only. If present, use an oxidizer such as air, oxygen, ozone, chlorine or hydrogen peroxide and retention time of 10 to 60 seconds prior to an iron filter. For peroxide, use prior to the Centaur Carbon backwash filters.

Bacteria - Bacteria include coliform bacteria, e-coli, heterotrophic bacteria, iron bacteria, sulfur-reducing bacteria and other bacteria such as h-pylori. Bacteria can cause health problems, as well as aesthetic problems like slime and odors. If these bacteria are present, use a disinfection system with an oxidizer such as chlorine or ozone, followed by a Greensand or Pro-OX, MangOX iron filter.

13. Iron Treatment Methods

Questions to ask: What type of iron do I have in my water system? Do I have manganese, hydrogen sulfide odor, iron bacteria or tannin in my water? What is the pH of my water? Will the pH have to be adjusted prior to treatment system?

Symptoms	Iron Type	Treatment Methods	Considerations
Tap water is first clear and colorless. After standing, reddish brown particles appear.	Clear Water Iron (dissolved ferrous iron)	Aeration/Filtration	Air injector (venturi type) may reduce water pressure. Air compressor type or Air Charger type offer some advantages.
		Water softener	Don't use softener alone if TDS is > 500 mg/l and pH is > 7.0.
		Chlorination + Greensand, Pro-OX, MangOX or Carbon Filter	Uses chlorine liquid or pellets. Requires adequate contact time.
		Greensand Filter	Uses potassium permanganate powder.
		Pro-OX, MangOX, Filox, Pyrolox or Birm	May require air injection (Birm) or chlorine feed if iron level is over 5 PPM
		Ozone + Greensand, Pro-OX, MangOX or Carbon backwash filter	High cost; must have proper contact time and a method to remove excess ozone gas

		Sequestering using polyphosphates	Best for use in irrigation systems. Keeps iron clear in water. Does not remove iron.
Tap water appears rusty or has a red or yellow color.	Red Water Iron (insoluble ferric iron)	Greensand Filter	Adequate pressure & flow to backwash filter system.
		Pro-OX, MangOX, or Birm	Adequate pressure & flow to backwash filter system.
		Chlorination/Filtration	Use of chlorine liquid or pellets.
Water tank, toilet tank have reddish brown or yellow gelatinous slime	Iron bacteria	Chlorination + Contact Tank + Filtration with Greensand, Pro-OX, MangOX and/or Carbon;	Chlorine products must be suitable for drinking water. Method requires contact time
Water may appear yellow or brown color. Source is shallow well.	Organic iron	Tannin Filter with or without a Greensand or other filter depending on water chemistry	Check for corrosive properties. System must be airtight.

13.1 Iron Filter Types and Operation

Birm Filters

Birm is a trademark name of the Clack Corp. These iron filters use a type of granular filter media called "Birm". It is manufactured from a type of natural pumice mineral coated with manganese dioxide. As the water flows through the filter tank containing Birm media, a reaction occurs where the dissolved oxygen and the dissolved ferrous iron compounds form an insoluble ferric hydroxide.

In plain English, as water containing iron flows through the media, if there is enough oxygen in the water, the Birm causes the iron to form rust, or solid iron particles. After these rust particles get trapped in the filter media, once or twice a week they are automatically backwashed out to drain, and the filter media is ready to filter again.

Birm is cheaper than other iron filter media such as Filox or Pro-OX, MangOX, but it has several limitations. It does not remove manganese or hydrogen sulfide gas which is often found in well water containing iron. It cannot be used if the water is chlorinated, and it is quickly fouled by iron bacteria. In most cases, Birm requires an air injector system to be able to work effectively. Birm will not work well if the pH is less than 6.9 – 7.0. Birm media may to be changed every 3 – 5 years.

Greensand Filters and Other Manganese Dioxide Coated Filter Media

Like Birm, Greensand and other coated media have a special coating of manganese dioxide, which oxidizes manganese and iron in water upon contact with the filter media. Unlike Birm, Greensand is not affected by chlorination and works over a wider pH range. Greensand iron filters will also remove hydrogen sulfide if the water is chlorinated prior to the filter.

To provide the oxidizing power to precipitate iron and manganese the iron filter is automatically cleaned and restored with potassium permanganate (a purple liquid) during each backwash cycle. As an option to using potassium permanganate powder, a chlorine injector pump is used ahead of the greensand-plus filter to regenerate the filter media. Greensand media generally needs to be replaced every 4 to 6 years.

Pro-OX, MangOX, Filox, Pyrolox (solid Manganese Dioxide) Filters

Unlike Birm and Greensand which are coated with a manganese oxide coating, these types of iron filters use a solid manganese oxide ore in a relatively pure form. The iron filters utilize an oxidation-reduction reaction and filtration process like Greensand, but at a much higher level of performance.

Pro-OX, MangOX contains greater than 85% manganese dioxide whereas Greensand contains around 1%. Pro-OX, MangOX and other solid manganese dioxide media are very heavy and require a strong backwash flow to lift and clean the media.

These types of filter media often last for 10 years or more, especially when used with a chlorine feed.

For most applications, the untreated water is first injected with an oxidizer such as air, chlorine or ozone. Because of the highly oxidative state of the Pro-OX media, aeration alone is often sufficient to provide the oxidation required.

Chlorine is most commonly used as a pre-oxidant which allows the filter media to work at a faster rate and last longer, in a process known as continuous regeneration. The media can also be regenerated at the end of its service cycle by rinsing with chlorine in a process known as batch regeneration or intermittent regeneration.

For the removal of hydrogen sulfide, Pro-OX directly oxidizes sulfide and catalyzes the oxidation reaction. Sufficient aeration or chlorine injection prior to the filter media should be used to insure long filter life.

For arsenic removal, chlorine changes arsenite (AsIII) to arsenate (AsV), and iron in the water is converted to ferric hydroxide, which allows the arsenate to form ferric arsenate, which is then removed by the Pro-OX media. For arsenic removal, sufficient iron must be present in the water for arsenic to be removed. A general guideline is 1 mg/L of iron must present to remove 20 ug/L of arsenic., but this can vary greatly depending on pH and other competing ions in the water, and pilot testing is recommended.

A strong backwash at the proper flow rate is required to keep the Pro-OX media clean. A rate of 12 to 15 GPM per square foot is recommended @ 60F, in order to be able to lift and expand the filter media, to wash out the trapped iron and manganese oxides.

13.2 Oxidizing Iron Filter Comparison

Iron Filter Type	Oxidizers Commonly Used	Iron Level Removed in PPM	Manganese Level Removed in PPM	Removes Hydrogen Sulfide	% Manganese Dioxide	Backwash Flow Rate Required	Weight per cubic foot
Birm	Air	15	0	No	< 0.5%	10 - 12	45
Greensand	Permanganate, Chlorine, Ozone	15	5.0	Yes with Chlorine Feed	< 2.0%	12 - 15	85
Pro-OX, Filox, MangOX	Air, Chlorine, Ozone, Peroxide	15	5.0	Yes	75% - 85%	15 - 20	120

Air Injector + Birm Iron Filter



Air Compressor + Birm, Pro-OX Filter



Greensand Filter + Permanganate Tank



Air-Charging Type Iron Filter



Chlorinator + Pro-OX or Greensand Filter



Ozone + Pro-OX or Carbon Filter



14. Sediment Filtration

There are many causes of "sediment" in water. Although sediment (those particles which can settle out in a jar of water) is often described as looking like dirt, soil or sand, it can be caused when dissolved metals such as iron precipitate out of solution.

It is important to properly identify the cause of the sediment before you choose the right filter or system. **For particles, less than 1 micron, an ultra-filter system is often required that can remove these sub-micron particles.**

Treatment options include whole house cartridge filters, filter strainers, and self-cleaning sediment backwash filters using sand or another type of filter media.

Some of the more common causes of sediment in water are:

- Silt, clay or sand particles from well water
- Iron or manganese oxides (rust)
- Black ferric sulfide from hydrogen sulfide
- Sand, grit or particles from improperly flushed pipelines
- Decaying piping and distribution systems
- Decaying water heater liners and dip tubes
- Decaying storage tank liners, pressure tanks, or pumping system.
- Water softening resin or other filter media from failed home treatment system

Various filter cartridges and different size filter housings are available to filter water of sediment. A common approach is to use a 50 micron, then a 5 or 1 micron filter in series.



14.1 Multi-Media Filters for Sediment Removal

Some systems utilize a multi-media filter using layers of gravel and sand— this is called “rapid sand filtration”. These systems have automatic control valves which control the flow and automatically backwash the filter based on either gallons used or on the pressure drop across the filter.

Multi-Media Depth Filter Design Parameters

Design parameters of a typical multi-media depth filter are as follows:

- Bed Depth 30 - 48 inches - 5 layers
- Bottom Layer Gravel 1/4" x 1/8" Larger tanks have a combination (support bed) of 1/2' x 1/4' x 1/8' Gravel
- Fourth layer #8-12 Garnet
- Third layer #30 - 40 Garnet
- Second Layer Filter Sand - .45 - .55
- Top Layer Anthracite or Filter-Ag

Backwash Rate 13-18 gpm/sq.ft.
 SERVICE FLOW RATE 12 gpm/sq. ft. or higher, depending upon local conditions

A support bed is mandatory and a specially designed distributor to handle high backwash rates.

An effluent water quality will be in the 10-20 micron range.

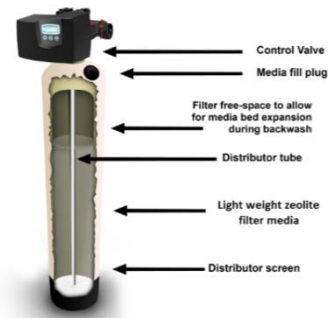
Multi-Media Depth Filter Loading Table												
Tank Diameter, Inches	10'	12'	13'	14'	16'	18'	21'	24'	30'	36'	42'	48'
Tank Height, Inches	44'/54'	48'	54'	65'	65'	65'	62'	72'	72'	72'	72'	72'
Bottom Layer									100	150	200	700
Gravel, 1/2" x 1/8"	12.5	20	25	30	50	60	80	100	100	150	200	300
Gravel, 1/4" x 1/8"												
Fourth Layer	20	250	25	35	50	65	85	100	200	250	350	450
Garnet, #8-12												
Third Layer	25	35	50	70	90	115	150	200	300	450	650	800
Garnet, # 30-40												
Second Layer	35	50	50	80	100	130	175	200	350	550	700	900
Filter Sand												
Top Layer - (Select One)	25	40	50	65	90	100	150	200	300	450	600	800
Anthracite of	12.5	20	25	30	45	50	75	100	150	225	300	400
Filter Ag												

Media in Pounds

Gravel.....	100lbs/cu.ft. - 50 lbs/bag	Sand .45 - .55	100lbs/cu.ft. - 50 lbs/bag
Garnet #8-12.....	140 lbs/cu.ft - 50 lbs./bag	Antracite.....	50 lbs/cu.ft - 50 lbs./bag
Garnet #30-40.....	130 lbs/cu. ft - 50 lbs/bag	Filter Ag.....	25 lbs/cu. ft - 25 lbs/bag



15. Water Softeners

Water, passing through the atmosphere as snow or rain, picks up carbon dioxide (CO₂) and other acid gases and reaches the Earth's surface as a weak acidic solution commonly referred to as carbonic acid.

The rain that falls into surface waters such as rivers, ponds and lakes is normally low in dissolved solids and hardness.

As this water soaks in, it passes through various strata containing limestone. The acid dissolves the calcium in the limestone until it is pH neutral and saturated with calcium carbonate. This is how calcium and magnesium end up in our water supplies. Where the calcium and magnesium content is high, these waters are described as "hard" waters.

Calcium carbonate is insoluble and deposits on the surfaces of water heaters, boilers, coffee makers, pipes and on to fabrics, creating hard scale (known as calcite, lime scale, boiler scale or hardness scale).

This scale is a poor conductor of heat and so it takes more energy to heat water if the heater element is covered with this calcium scale. Scale can also clog up pipes and appliances and reduce the life of fabrics due to its abrasive nature. In addition, when bathing you will notice the soluble calcium and magnesium salts will react with soap causing the familiar bathtub ring and soap scum. It is usually desirable to remove hardness ions before using the water in residential as well as industrial applications.

Ion exchange is the best to remove these hardness ions. In domestic applications, a low level of hardness can be permitted. If the water is over 8 to 10 grains per gallon, or about 150 mg/liter, it is desirable to remove it by water softening.

Hardness is measured in "grains per gallon." Over 8 grains is considered hard water.

1 Grain per gallon = 17.1 mg/L

What is a Water Softener?

A water softener is a special type of automatic self-cleaning filter that removes the calcium and magnesium in hard water by using plastic beads called ion-exchange resin. Softeners are cleaned automatically and periodically by a process called "regeneration." Water softeners have three main components: a mineral tank, brine tank and control valve. Smaller capacity models combine the mineral tank and brine tanks into one cabinet, but the two tanks are still separated within the cabinet. Larger flow capacity systems have separate stand-alone mineral and brine tanks.

Mineral Tank: The mineral tank is where the actual water softening (filtration and removal of hardness minerals) takes place and the hard water is softened (calcium and magnesium are removed). The incoming hard water passes through the softening resin, which is a type of special plastic bead. These beads are often made of polystyrene and may also be called resin beads or other names. The resin beads have a negative charge and attract the calcium and magnesium minerals, which have a positive charge, from the water. Since opposites attract, electricity does the work for us as the hard water minerals are removed from the water and stick to the resin. As the minerals are being removed, an almost equal amount of sodium is exchanged back into the water. The result is that the water is softened.

Brine Tank

Brine Tank: Brine is simply a mixture of salt and water. The brine tank is where a highly-concentrated solution of salt or potassium, with some water, is stored. The brine solution is typically made with regular salt (sodium chloride) but potassium salt (potassium chloride) is often used as well.

Control Valve: The control valve is the device that controls the flow of water into and out of the mineral and brine tanks and allows the softener to automatically backwash and regenerate. Usually the control valve has a built-in flow meter, that senses the amount of water being used, and then starts a regeneration based on the amount of water that has passed through the control valve and softener. The control valve is where the hardness level is programmed and the settings are adjusted for the water condition. During regeneration (which, with single tank softeners, usually occurs in the middle of the night when no water is being used) brine is drawn from the brine tank and the resin is cleaned and regenerated with the sodium brine.

How to Size a Water Softener

Softeners come in various sizes, each rated by the number of grains of hardness they can handle between regenerations. Units rated from about 12,000 to 16,000 grains are considered small; medium-size units run from 20,000 to 48,000 grains; and large-capacity models can handle 48,000 grains or more.

You can determine the size of softener your family needs by multiplying the number of people in your household by 75, the average number of gallons used per person per day, and then multiplying this number by the number of grains per gallon of hardness minerals present.



So, for example, if you have a family of four, you might use 300 gallons of water are used per day. If your water has 20 GPG, figure 300×20 and you have 6000 GPG requiring removal each day.

Consider using a water softener that can run for several days to a week between regenerations. For instance, a 48,000-grain softener would allow you to use water for 4 to 6 days before the softener needs to regenerate.

After the softener, has been used for several days or more, the softening resin will become “exhausted” meaning it will not be able to absorb or filter any more water of hardness. It is not a good practice to allow the water softener to become totally exhausted each time, as it will shorten the life of the resin. It is better to set the softener so it regenerates while the water is still soft, so the softener is not exhausted of its capacity before regeneration. This is covered by most water softener installation manuals and easy instructions are typically provided showing how to set the softener for best results.

Softeners and Septic Tanks: Myth and Reality

Myth 1: The salt-brine discharge from water softener regeneration is toxic to the bacteria in the waste treatment system.

In the study by NSF International, “The Effect of Home Water Softener Waste Regeneration Brines on Individual Aerobic Treatment Plants,” tests undertaken in response to a request from the Ohio Department of Health confirmed that water softener waste effluents exert a beneficial influence on a septic tank system operation by stimulating biological action in the septic tank and cause no operational problems in anaerobic or aerobic on-site waste treatment systems.

Myth 2: Water softener regeneration discharges reduce the percolation of water through soils, by causing a swelling of the soil particles.

University of Wisconsin Small System Waste Management Project Research showed that water softener regeneration wastes not only do not interfere with septic tank systems’ drain fields, but could actually improve soil percolation. In many studies, most evidence points to the fact that home water treatment discharges do not harm on-site waste water or septic tanks systems. In fact, millions of home water treatment systems are operating and have been for decades quite successfully while discharging waste water into septic tanks.

16. No-Salt Water Conditioners

An alternative to traditional water softeners, no-salt water conditioners treat the water so the hardness minerals are transformed into a form which will not stick to pipes, appliances, or fixtures.

This process is referred to as Template Assisted Crystallization ("TAC").

The water is not softened, and no hardness minerals are removed. However, for some homeowners and commercial applications, this can be a good alternative to traditional water softeners.

Traditional water softeners use salts to exchange hardness calcium minerals with sodium ions. Salt-free water conditioners change the composition of the calcium minerals in the water to discourage scale formation that collects on household appliances and in pipes.

Advantages include:

- Consistent scale control: eliminates problems with calcium scale in pipes and appliances
- No salt required. No backwash or waste water is produced.
- Works for both residential and commercial applications
- Economical and energy efficient: Uses no waste water and requires no electricity.
- No maintenance required.
- Retains beneficial minerals naturally occurring in your water: Salt-less conditioners won't leave your water with a slimy or slippery feel as often happens with salt softeners.
- Compact, uses less space than most water softeners.

For more information, read the [Arizona State University Study on Template Assisted Crystallization](#):

[Arizona State University Study](#)

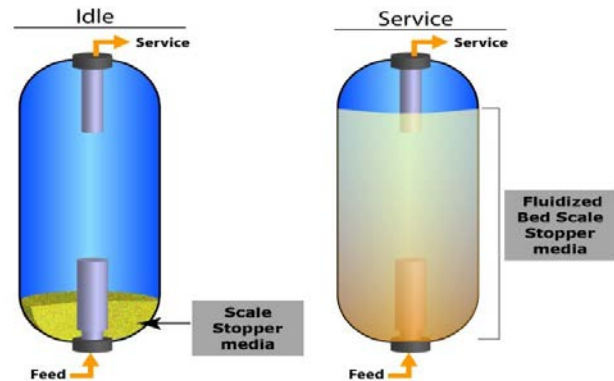

17. Reverse Osmosis

Reverse osmosis systems use semi-permeable film membranes to separate and remove dissolved solids, organic material, pyrogens, submicron colloidal matter, viruses, and bacteria from water. Feed water is delivered under pressure to the membranes where reverse osmosis takes place. Water permeates the minute pores of the membrane and is delivered as purified product water. The impurities in the water do not pass through the membrane, and are instead concentrated in the reject stream that is flushed to the drain.

While ordinary filters use a screen to separate particles from water streams, a reverse osmosis system uses a semi-permeable membrane to separate a high percentage of dissolved molecules. Only certain types of molecules, like water, can pass through the membrane. Other molecules, like salts, do not pass through the membrane and are left behind.

A semi-permeable membrane is made of thin, multi-layered sheets with microscopic pores that let water pass through while acting as a barrier to stop dissolved particles like salt.

THE REVERSE OSMOSIS MEMBRANE ELEMENT

CONCENTRATE WATER containing salts is rejected by the membrane and does not enter the product tube. The concentrate water exits the side of the element opposite of the feed.

RAW WATER FEED enters into membrane layers. Applied pressure forces raw water across membrane layers into the product tube.

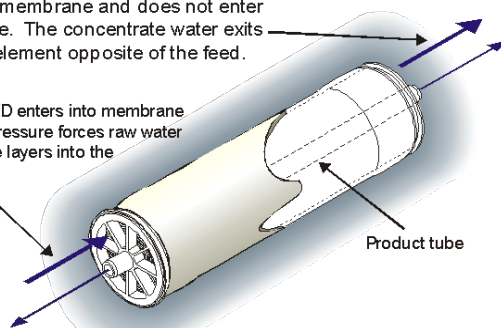

PRODUCT WATER collects in the product tube and can be output from either end of the membrane element.



Whole House/Commercial Reverse Osmosis System

17.1 Under-Sink Reverse Osmosis Systems

Under-sink reverse osmosis systems are used to purify water of sodium, total dissolved solids, metals, and other inorganic impurities in water. They also include carbon filters which remove chlorine tastes and odors, along with other organic compounds such as pesticides and herbicides.

A reverse osmosis system that makes claims to remove contaminants that affect health (such as lead) will be certified by a third-party certification organization such as NSF, U.L, or WQA.

The under-sink reverse osmosis (or "RO") systems are sized in their output in gallons or liters per hour or per day. A typical home system will produce between 25 and 50 gallons per day for instance. Under-sink RO systems use a separate faucet to dispense the purified water.

Purified water can be supplied to icemakers and on-door water dispensers if the production of the RO is sufficient and there is a large enough pure water holding tank.

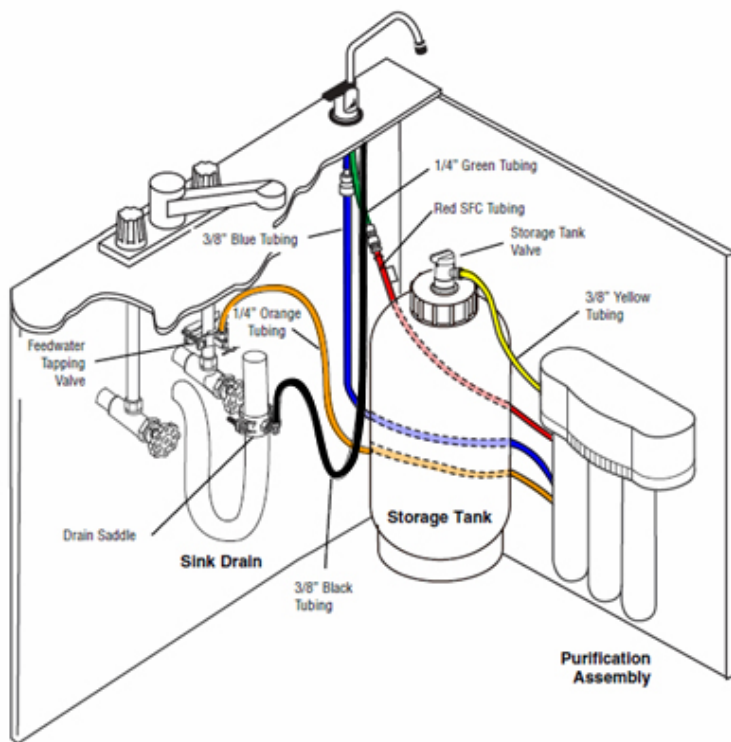

17.2 Whole House Reverse Osmosis Systems

In some cases, the total dissolved solids are so high (typically over 1000 mg/L) that it is necessary to remove them for all the household water use.

Advantages of whole-house reverse osmosis systems are that your water will be of drinking quality throughout the home, and not corrosive to piping and fixtures. If the piping in the home is copper, the final stage of the whole house RO system will include a calcite neutralizer that adds some minerals back into the water after the RO system has purified the water of total dissolved solids.

This type of RO system has its own booster pump to boost pressure from the line pressure of 50 or 60 PSI up to 200 PSI for TDS of 2000 to 3000 mg/L, and up to 400 to 900 for brackish and seawater applications.

Common features include pressure gauges, a control panel for wiring and controlling the RO system, and flow meters that show the pure water flow rate, waste water flow rate, and recycled water flow rate. Many RO systems will also include TDS meters and flow sensors to track water quality and trip an alarm should the water quality deviate from standard settings or the RO system require service.

Typical whole house RO systems have six main requirements:

1. Adequate pre-treatment to remove iron, manganese and solids
2. Disinfection to remove bacteria that may foul the RO membranes
3. Anti-scalant control which includes either a water softener or an anti-scalant injection system using a non-toxic chemical
4. Adequate pressure and flow before the RO system
5. Neutralizer for pH and minerals to make the water non-corrosive
6. Storage tank with booster pump to hold the purified water



Typical Whole House RO System Using the Well Pump Directly

This type can purify the water directly from the well using the well submersible pump to supply the feed water to the pre-treatment and the RO system. The water fills a holding tank.

In this type of RO system, the untreated well water is filtered for iron and manganese with a Pro-OX (or greensand etc) iron filter, then a sediment backwash filter for turbidity reduction. If the water contains high levels of hardness over 3 – 5 grains per gallon, a water softener or anti-scalant injection system is used prior to the RO system.

The water is purified of dissolved solids by the reverse osmosis system and then flows through a calcite neutralizer, which adds a small amount of calcium back into the water to prevent corrosion of household piping. If the water is to be used for irrigation only, or in a bottling plant, often no calcium is added.

This design can be used for waters high in iron, manganese, and total dissolved solids.

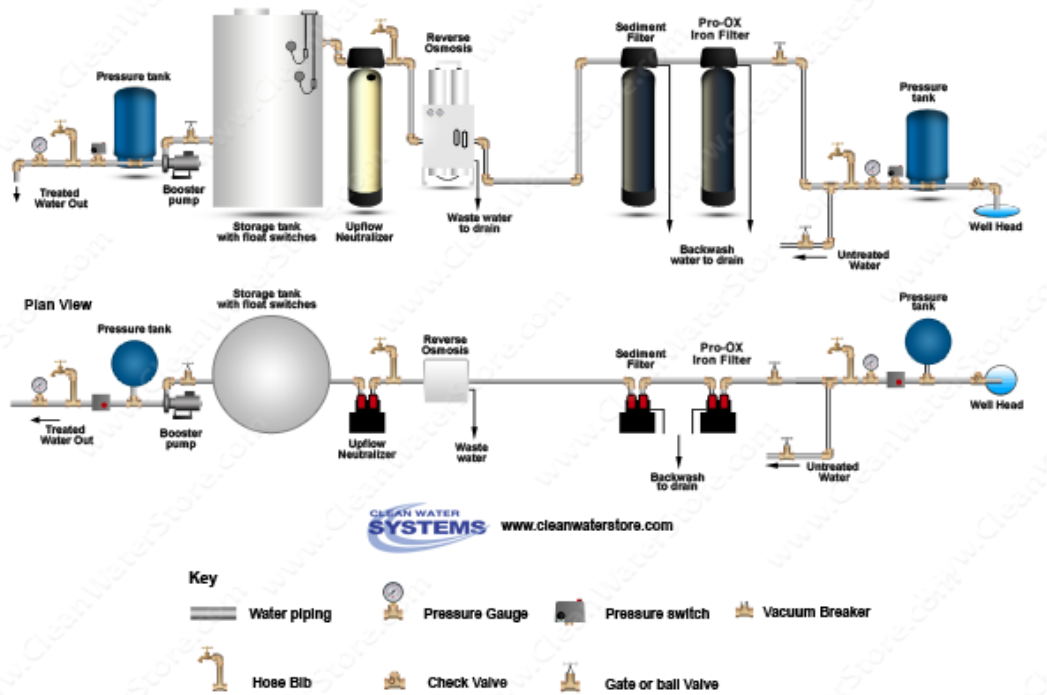

Typical Whole House and Commercial RO System with Chlorinator

In this type of RO system, water is injected with chlorine (optional contact tank not shown) killing bacteria and oxidizing iron and manganese. The water is filtered for iron and manganese with a Pro-OX (or greensand etc) iron filter, then a carbon filter, then water softener (if water contains hardness).

The water is purified of dissolved solids by the reverse osmosis system and then flows through a calcite neutralizer, which adds a small amount of calcium back into the water to prevent corrosion of household piping. If the water is to be used for irrigation only, or in a bottling plant, often no calcium is added.

This design can be used for waters high in iron, manganese, odors, TDS, arsenic and other contaminants.

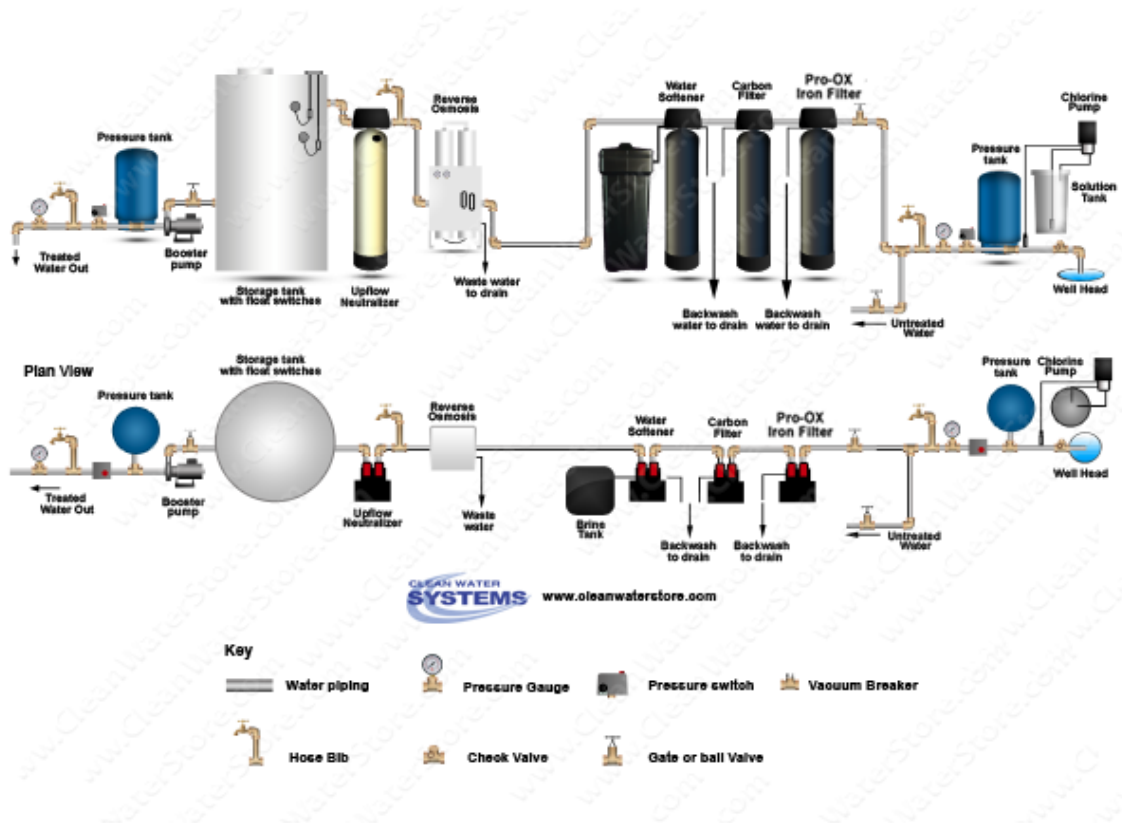

18. Ultrafiltration

In cases where the turbidity is high or where very fine colloidal particles are present, ultra-filtration (“UF”) systems can produce clear water for household and commercial use. Ultra-filtration membrane technology is used to filter municipal, well, cistern, lake and river water. They are easy to install, generally near a water heater, in new or existing homes.

These filter systems use hollow-fiber “ultrafiltration” membrane technology to filter impurities as small as 0.025 microns. To maximize membrane capacity and service life, a metered flushing cycle is used to clean the membrane based on water usage or pressure drop. The self-cleaning forward and back-flush cycles are initiated when the programmed capacity of the membrane is reached. During the backwash, flow is reversed and particles are ejected from the pores of the membrane

Often these systems (manufactured by companies such as Antunes, Pentek, and G.E. Water) appear as shown in the following illustration. These systems work great for surface water applications such as lake, creek and river water, though additional disinfection with chlorine, UV, or ozone is recommended for an additional safety factor.

Pentair FreshPoint UF System Diagram

System Specifications and Performance Data

Membrane	
Material*	Polyethersulfone, modified (PESM)
Pore Size	0.025 micron (nominal) 0.065 micron (absolute)
Molecular Weight Cut Off (MWCO)	100-150 kD
Active Membrane Surface	51 sq. ft.
Service Flow Rate @ 15 psi drop	6.23 gpm to 10 gpm (1,416 L/h to 2,271 L/H)
Controller	
Electrical Rating	50/60 Hz
Forward Flush Cycle	1-99 minutes
Metered Volume	1-9999 gallons
Meter Accuracy	1-50 gpm +/- 5%
System	
Inlet/Outlet	3/4-inch NPT

Pentair Water Solutions for Complete POE Treatment



19. Nitrate Removal

Nitrate is a naturally occurring chemical compound that is formed in the soil when nitrogen and oxygen combine. Small amounts of nitrate are normal but large amounts can pollute groundwater and cause severe consequences to life.

Sources of Nitrate

Sources of nitrate in the soil are chemical fertilizers, septic system discharge and livestock waste. A portion of chemical fertilizer will convert to nitrate in the soil. Ammonia is present in the waste of both humans and animals. It enters the soil from inadequate or poorly managed septic systems. Plants can only absorb a certain level of nitrate from the soil. The excess is then carried down through the soil into the groundwater by the action of rain, snowmelt and irrigation.

Health Problems Associated with Nitrate

The consumption of small amounts of nitrate is not harmful; nitrate is a part of a normal diet. However, health problems can arise from excessive ingestion of nitrate. When nitrates enter the body, stomach bacteria convert nitrate to nitrite. Adults have low pH (high acidity) stomach acid that destroys this nitrite producing bacteria.

Infants, however (especially those less than three months in age), do not have developed digestive systems that can destroy the stomach bacteria, so infants can develop excess amounts of nitrite in their bodies and develop methemoglobinemia.

Methemoglobin is a converted form of hemoglobin, which is found in red blood cells and normally carries oxygen in the body's bloodstream. In methemoglobin form, these cells are unable to transport oxygen and these infants now become oxygen starved. Because oxygen starvation results in a bluish discoloration of the body, methemoglobinemia has been referred to as "blue baby syndrome".

Once an infant's system is fully developed (normally three to six months), methemoglobinemia is a rarely a problem. Methemoglobinemia, if recognized by a physician, is relatively easy to treat and babies can make a full recovery.

Livestock are also susceptible to nitrate poisoning; however they too can be treated and fully recover. For more information regarding methemoglobinemia or nitrate ingestion in general, please consult your family doctor.



Nitrate Filters look and function similar to water softeners but have a different type of resin filter media. They do not soften water but do remove nitrate & sulfate.

Nitrate Testing Is Important

The United States Environmental Protection Agency (EPA) recommends that well users test their water every one to three years for total nitrate and biological content. If the taste, odor, or appearance changes, then the water should be tested more frequently. Nitrate is either expressed in reports as Nitrate-N (nitrate as nitrogen) or Nitrate as Nitrate. The maximum contaminant level (MCL) for nitrate-N is 10 PPM (also known as milligrams per liter). To express nitrate as nitrate, multiply by 4.4: for example, the MCL for nitrate as nitrate is 44 PPM.

The primary causes for nitrate contamination in groundwater are failed, overloaded, or improperly constructed septic systems, as well as animal waste and fertilizer. Water that comes in contact with these sources will absorb nitrate and carry it down into the soil eventually ending up in the groundwater.

Reducing the Risk of Nitrate Contamination

EPA recommends homeowners follow these guidelines to reduce the risk of nitrate contamination:

1. Reduce your use of fertilizer: use commercial fertilizers only when necessary, and always according to the manufacturer's recommendations. Never over-fertilize.
2. Proper well construction: A well should always be located up-gradient or in reverse direction of groundwater flow direction from your septic system. There should be a minimum of 100 feet separating your well from your septic tank and leach field, whichever is the closer (contact your county health department as their requirements could be greater). Your wellhead casing should extend above the ground and be protected within an earthen berm (a conical mound) to divert surface drainage away from the wellhead. Make sure that the well casing has at least a 50-foot-deep annular seal of cement (grouting around the well casing) and a concrete slab covering the wellhead.
3. Operate and maintain your septic system correctly: Proper maintenance and operation of your septic system is critical in saving money and avoiding system failure, which will ultimately lead to groundwater contamination and the possibility of health-related issues.

Follow these simple rules:

- Don't dispose of chemicals or non-biodegradable materials in your drain or toilet.
- Don't plant trees or shrubs near drain lines or the leach field.
- Don't drive vehicles over the septic tank or leach field.
- Have your septic tank pumped out at least every two to three years.
- Conserve water: If you have two leach fields, alternate their use yearly.
- Install a lint trap on your washing machine

Nitrate Treatment and Removal Technologies

Technologies include: Ion-exchange, Reverse-osmosis, Distillation, Bio-denitrification, Electro-dialysis.

The most commonly used treatment approach is ion-exchange, the same technology water softeners employ. With this type of system, chlorides are exchanged for the nitrate, and the high nitrate waste is flushed into a holding tank or drain field. Like a water softener, salt is added to a salt tank, and the nitrate resin is regenerated automatically with salt water. If you are on your own private well you can choose to either remove the nitrate throughout the house, or purify at one or more faucets.

Pretreatment and total system design is important. If you are looking for a nitrate filtration system for your small community water system, each system installed must be certified by the Health Dept. for nitrate removal. Typically, all the water must be filtered, and individual point-of-use filters at kitchen taps are not allowed for compliance with the nitrate MCL standard.

Nitrate systems remove both nitrate and sulfate, so it is important to know both the nitrate and sulfate levels.

How to Calculate How Often to Set System to Regenerate:

Example: nitrate is 10.0 PPM as nitrogen or 44.4 PPM as nitrate;

Change nitrate to nitrate as nitrate by multiplying times 4.4

Test for sulfate and note sulfate level.

Example calculation:

Nitrate level (as NO₃): 44 PPM x .81 = 36 PPM as CaCO₄

Sulfate: 34 PPM x 1.04 = 36 PPM as CaCO₄

Total sum of NO₃ and Sulfates as CaCO₄: 72 PPM

72 PPM divided by 17.1 = 4.2 grains (round to 5 grains for conservative calculation)

Capacity of resin = 16,000 grains per cu ft.

Total cubic foot of resin in system: 1.5 cubic foot which = 24,000 grains

24,000 grains divided by 5 grains = 4800

Add in a safety factor to prevent the resin from becoming exhausted each time before regeneration. The safety factor would be the maximum amount of water used in one day.

Typically, one can estimate 80 gallons used per person per day. A four person home would use 320 gallons as a buffer or safety factor. So the nitrate filter in this example would be set to regenerate approximately every 4480 gallons.

20. Tannin Removal

The word “tannin” refers to a family of organic acid plant extracts (fulvic, humic, and tannic acids). The presence of color in water can stem from several sources. Although often termed tannins (organics), color can be caused by inorganic sources such as iron or manganese. Simple field tests can confirm Fe⁺⁺ or Mn⁺⁺ and subsequent removal is rarely done by tannin filters, which use ion-exchange resin in a device that looks similar to a water softener. If, however, the color problem is determined to be organic, ion exchange provides an excellent and easy solution.

Sources

Tannins are sometimes referred to as “natural organic matter” and come largely from decaying vegetation.

They can be completely soluble or suspended as colloidal or very small particles suspended in water.

Tannin Filter Design

The tannin media can be layered on top of a softening resin bed if the total hardness of the water is less than 10 gpg and there is less than 0.4 PPM iron. If the hardness is higher than 10 gpg and more than 0.4 PPM iron then the water must be softened first, in a separate softener tank.

Iron removal should also be used prior to the softener if conditions are such that the softener cannot reduce the iron to less than 0.4 PPM. Generally, its better to have a separate tank for the tannin resin since the tannin resin must be regenerated at a different frequency than water softeners.

Tannin Filters look like and function similar to



A typical capacity for tannin filters is 2,000 PPM of gallons per cubic foot. Example: there are 2 PPM tannins in a water sample. 2,000 divided by 2 = 1,000 gallons per cubic foot. The salt dose should be 10 lbs per cubic foot.

Tannin removing resins must be regenerated at least once every 3 days. After 3 days the tannins may irreversibly foul the resin.

21. Neutralize Acid Water

On private well water systems one of the most common causes of corrosion is **acidic water**. The pH scale is used to determine how acidic or alkaline water chemistry is.

Acidic water has a pH of less than 7.0. For example a pH of 6.0 to 6.5 is a common pH range found in wells with acidic water. Signs of acid water are corrosion of fixtures, blue staining (from copper pipes) or rust staining (from iron pipes). Acidic water can also cause pinhole leaks and pipe failure over time.

By raising the pH to the range of 7.0 to 7.5 the water can be made alkaline which will then reduce or eliminate pipe corrosion.

Corrosion is a natural process involving chemical or electrical degradation of metals in contact with water. The rate of corrosion will vary depending on the acidity of the water, its electrical conductivity, oxygen concentration, and temperature. Acidic water with pH values in the range of 6 to 7 is more corrosive to the metals used in plumbing systems than alkaline water. Both ground waters (wells) and surface waters (such as spring water or creeks) can be acidic.



Cut-away of copper pipe showing blue green corrosion.



Corroded leaking water heater caused by acid water corrosion.

Auto Backwash Acid Neutralizer Filter System Flow Diagram Not to scale

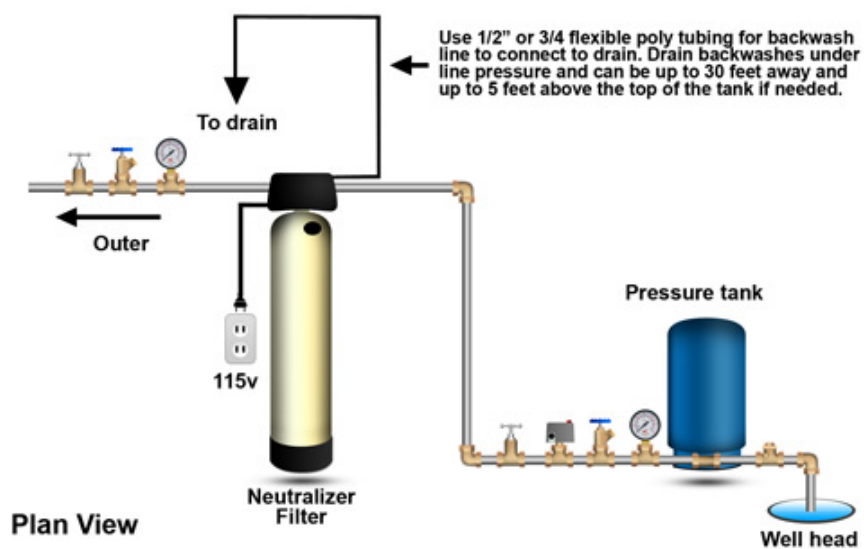

Common causes for acidic water are acid rainfall due to atmospheric carbon dioxide and other airborne pollutants, runoff from mining spoils, and decomposition of plant materials.

Acidic waters can be of good quality and are often low in minerals and salts, but are high in dissolved carbon-dioxide gas, which can cause the acidic condition.

21.1 Down-Flow Calcite Neutralizers

Neutralizers work by adding natural calcium and magnesium to the water.

Down-Flow neutralizers have backwashing control valves: In a standard down-flow neutralizer the water enters the top of the tank and flows down through the media and up the distributor tube.

The down-flow type neutralizer removes sediment during backwash, which cleans the calcite, preventing channeling.

The calcite media is two-thirds full in the tank when new or recently serviced.

During backwash, the water flow is reversed.

Water flows down the distributor tube and up through the media, lifting and expanding the calcite media, which cleans the calcite by the action of the water flowing through it.

Down-flow backwashing neutralizers make good filters and remove sediment down to the 30 – 50 micron range. After six to twelve months more calcite is added to bring the media level from half full back to two-thirds full.



Acid neutralizer with backwash control

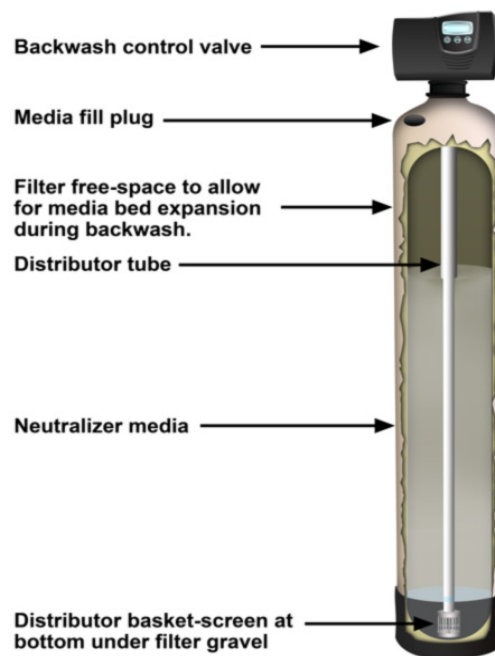

21.2 Up-Flow Calcite Neutralizers

Up-Flow neutralizers do not have or need backwashing control valves.

In an up-flow neutralizer the water always flows down the distributor tube and up through the calcite media. Up-flow neutralizers have no backwash control valve and are not backwashed, because the water is always flowing up through the calcite so there is no need for a backwash.

This type may work well in some applications and prevents the need for any backwash drain connection. However the up-flow can have problems with channeling where the water can bypass some of the media.

Be sure to put a filter after an up-flow neutralizer to catch any calcite that may rinse into the downstream piping and cause damage to fixtures and appliances.

Some up-flow neutralizers have internal top-screens that prevent the calcite from entering the house. Only use this type on clean disinfected water however, as over the years slime and sediment builds up on this internal top screen and cuts back on water pressure.

Up Flow Neutralizer - showing gate or ball valves installed before and after the neutralizer. A hose bib is shown after the neutralizer for rising the media after putting into service. An optional filter cartridge can be installed after the neutralizer to power calcite from accidentally rising into the household during normal use.

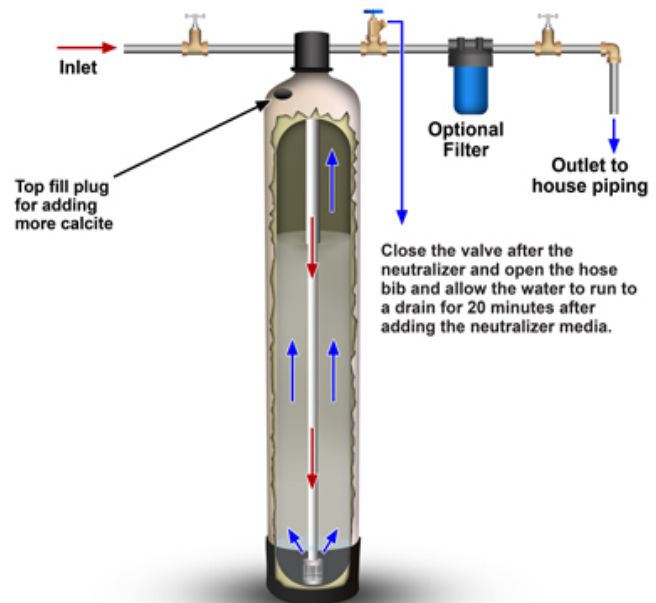

Close the valve after the neutralizer and open the hose bib and allow the water to run to a drain for 20 minutes after adding the neutralizer media.

21.3 Soda Ash Feeders

In some cases, instead of dissolved carbon dioxide causing the low pH or acidity, the acidity is caused by mineral acids, either natural or from mining or other industrial wastes. In this type of water, the pH is often less than 5.0. A soda ash feed pump is used, and in some cases injection of the much more powerful alkaline solution sodium hydroxide is required.

A small pump called a metering pump is used to inject a small amount of soda ash (sodium carbonate) into the water, usually in combination with a contact tank. For best results, allow a few minutes of contact with the water for pH adjustment to occur and the soda ash solution to thoroughly mix in the water by using a contact tank. For home wells the metering pumps are usually wired to turn on and start pumping soda ash solution when the well pump is energized or running.

Soda ash is bought dry, usually in 25 or 50 lb. bags, and mixed with soft or pure water in the solution tank. When a saturated solution is achieved (approximately 3 pounds per 5 gallons of water, which creates a 10% solution), a solution of between 50 and 500 PPM is injected, depending on the pH, alkalinity, and flow rate of the water.

**Soda Ash Injection to Raise pH; for Well System with pressure and Contact Tank
Flow Diagram Not to scale**

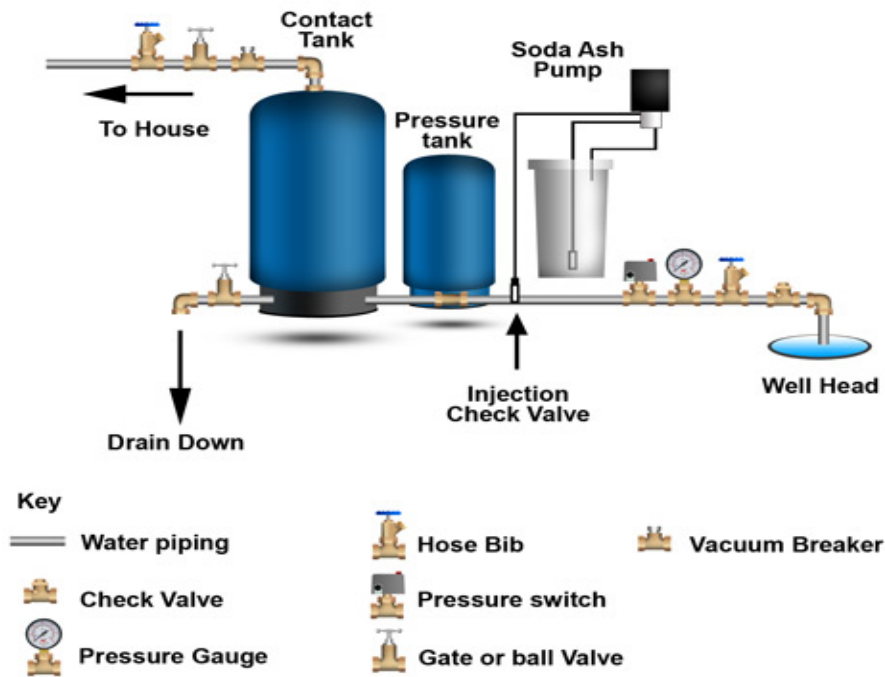

22. Eliminating Odors

Hydrogen sulfide gas and the resulting “rotten egg” sulfur odors are typically caused by the reaction of sulfates and microorganisms in ground water. In some areas, the hydrogen sulfide gas is a result of decaying vegetation and organic matter. This gas and odor can occur in the well directly, or in the household plumbing in both hot and cold water pipes, or in only the water heater and hot water lines.

Sulfur-reducing bacteria, which use sulfur as an energy source, are the primary producers of large quantities of hydrogen sulfide. These bacteria chemically change natural sulfates in water to hydrogen sulfide. Sulfur-reducing bacteria live in oxygen-deficient environments such as deep wells, plumbing systems, water softeners and water heaters. These bacteria usually flourish on the hot water side of a water distribution system, and in some cases the water heater itself is the source of the hydrogen sulfide.

A gray or black color is often associated with hydrogen sulfide gas in water and it can tarnish fixtures and corrode metals such as copper, brass and iron. Hydrogen sulfide can affect the taste and color of cooked food, tea and other beverages. Sulfur bacteria can cause slime build-up in toilet tanks.

Cold Water Odor or Hot Water Odor?

To determine the source of the odor and decide on the type of treatment required, it is important to first check to see whether the cold water contains odor, or just the hot.

- Run the hot water to check for the odor. Then move to another faucet and run the cold water. If the cold water has an odor, then the source is in the cold water.
- If the hot water alone has odor, then the odor is occurring primarily in the water heater.
- Next, go outside and determine if the well water contains odors directly from the well by running water outside the home, before it enters the home piping.

Odors Caused by Bacteria & Sulfates

Some well waters contain an excessive amount of sulfates with various strains of sulfate bacteria. These bacteria, while harmless to health, will react in stagnant water that has been depleted of oxygen, and will produce hydrogen sulfide gas.

If your well water is used directly from the well, and not aerated in an atmospheric (non-pressurized) storage tank, then the odors are most likely caused by anaerobic bacteria. These types of bacteria thrive in oxygen-deprived environments, and often on waters high in sulfates. If the cold water entering the home contains no odor, odor can still develop in cold water piping in the home, especially in galvanized iron piping. Often iron piping in the house is of an older age and can be corroded, providing a good environment for the bacteria to grow and odors to develop.



If there is an odor in the cold water inside the home, but not directly from the well, see if the piping is iron piping, and then replace it with copper. As a first step to this process, one can shock-chlorinate the piping and sanitize it, and see if the odor can be eliminated.

Water Heater Odors

If the odor is in the hot water only, then a shock-chlorination of the water heater and servicing or replacing the anode rod in the water heater can eliminate this problem.

Almost all water heaters have “anode rods” which, via a cathode-anode reaction, produce excess ions that wear off the anode rod and adhere to the inside glass lining of the water heater, preventing corrosion. These bacteria (typically the “desulfovibrio” or a related species) can be killed with adequate amounts of chlorine by periodic shock chlorination, by continuous ozone or chlorination, or by turning up the water heater to extremely high (but often dangerous) temperatures.

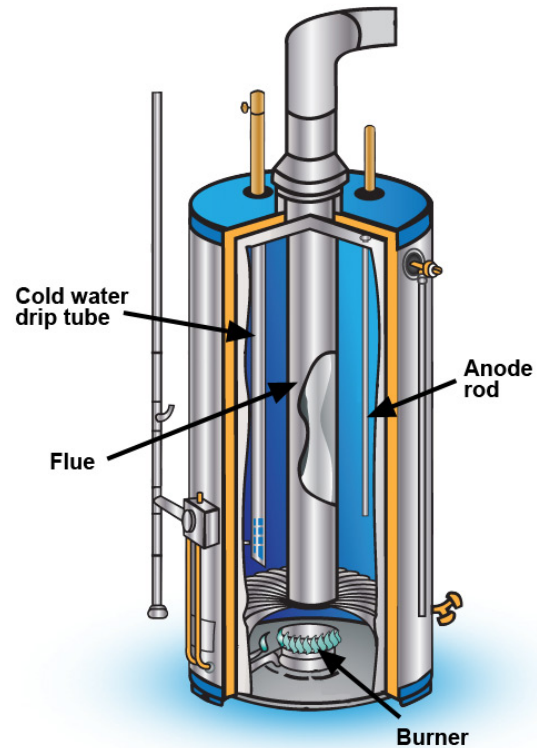

Odors Present Directly from Well Water (outside house)

One of the following methods is typically used to remove hydrogen sulfide gas and most other odors from well water:

- Periodic shock chlorination with high doses of chlorine
- Aeration of the water combined with periodic shock chlorination.
- Chlorine, hydrogen peroxide, or ozone injection alone
- Filtration of the odor by greensand media, activated carbon, or other filter media
- Chlorine or ozone injection followed by filtration with greensand, activated carbon, or other media.
- Hydrogen peroxide followed by Centaur or equivalent activated carbon.

Periodic shock chlorination with high doses of chlorine

This involves injecting into the well, pump system, and piping a 50 to 200 PPM dose of chlorine. The chlorine residual can sit in the well for 6 to 24 hours, and then the water is pumped out until the chlorine residual is gone. This will typically eliminate the odor problem temporarily.

If the odor returns, often within a couple of days to a few weeks, the procedure can be repeated. If the odor is still present after a couple of repeated shock-chlorination procedures, one of the other methods will need to be used.

Aeration of the water to oxidize the hydrogen sulfide gas, combined with periodic shock chlorination.

Since the bacteria that create the hydrogen sulfide odor are usually anaerobic, or bacteria that cannot thrive in oxygen rich environments, often aeration in a non-pressurized vented holding tank is beneficial to eliminate the gas and drive it off into atmosphere. This works best if the pH is low (less than 7.0) since the hydrogen sulfide gas at pH higher than 7.0 will not easily gas off completely. If you don't have a storage tank or plans for one, you can also use an air-compressor vent tank type system, which injects air under pressure and is often used with a carbon or iron filter system.

About pH and odor control: the higher the pH, the more chlorine, peroxide, air, or ozone will be required. If the pH is over 8.5, hydrogen peroxide combined with aeration is a very effective method to control odors compared to chlorine or just aeration.

Continuous Chlorine Injection

Odors can be controlled in water by chlorination, followed by retention or contact time and aeration. Chlorine is a powerful oxidizer, and while not as powerful as ozone by weight, is less expensive to install and operate than ozone systems.

Usually 2 to 3PPM of chlorine is injected for every 1 PPM of sulfide; however, if the pH is over 7.8 it can take up to 5 to 10 PPM of chlorine per 1 PPM of sulfide to treat hydrogen sulfide. If the pH is over 8.0, we usually recommend ozone or hydrogen peroxide injection instead of chlorine bleach.

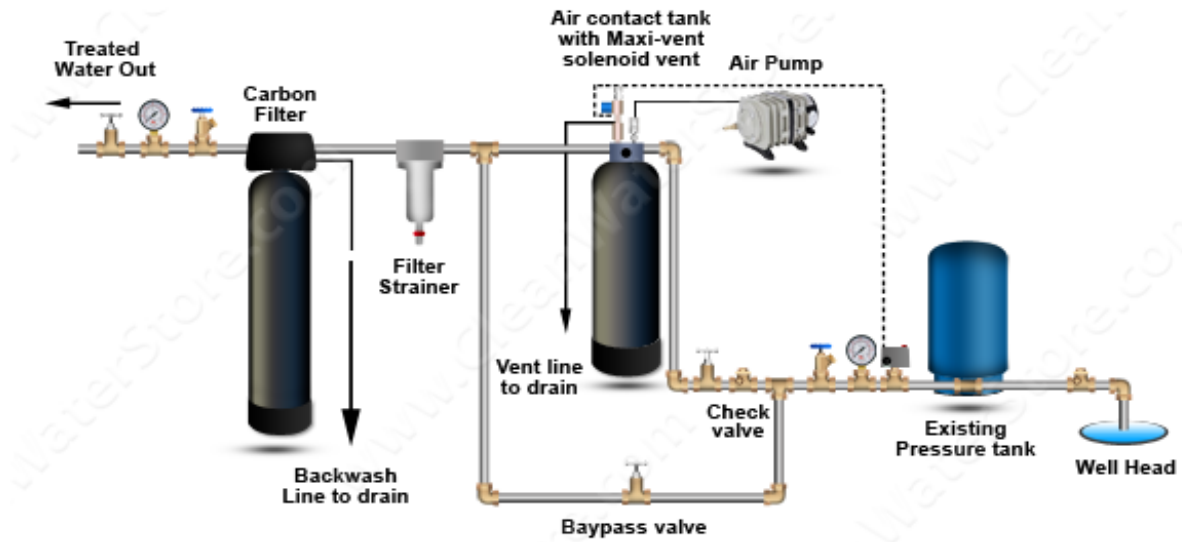

Air Compressor Systems for the Removal of Odors

Hydrogen sulfide gas odors can be removed by carbon, KDF, greensand or other types of media filtration but results vary, and usually filtration alone is not effective.

Catalytic carbon combined with air injection is a very effective approach and works much better than carbon or filtration alone without air injection.

In this system, an air compressor is used to inject air into the water under pressure, so no additional storage tanks or booster pumps are needed. After injection into a first pressurized tank, the air vent allows excess air to escape.

The water then flows to the second tank which filters out the oxidized particles and any oxidized iron and rust.

Aeration can be quite effective at removing odors especially when there is no iron or sulfur bacteria present.

For odor removal, the combination of air injection, followed by catalytic carbon works great.

In some cases, for extreme conditions, chlorine or hydrogen peroxide is injected prior to the aeration tank.

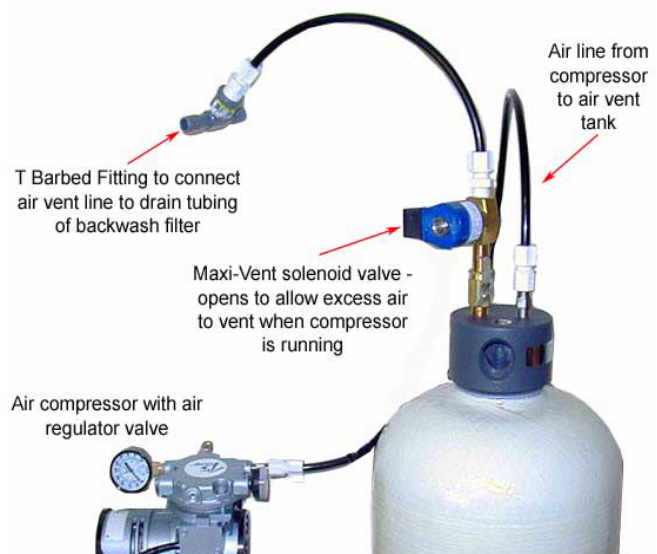

Remove Odors with Chlorine and Greensand Filtration System

In a chlorine and greensand filtration system, the well pump is controlled by a pressure switch. When pressure in the pressure tank drops below the cut-in point on the pressure switch, the well pump and chemical feed pump turn on simultaneously. As water is pumped through the system, a small amount of chlorine is pumped into the water by the metering pump.

As the water flows into the contact tank, the chlorine is thoroughly mixed in the water, allowing contact time to kill any bacteria and oxidize any iron, manganese, or hydrogen sulfide gas. Precipitated oxidized particles of iron, sulfides, and manganese are filtered out of the water by the greensand-plus media filtration system.

Periodically, the filter is backwashed automatically and oxidized particles are flushed down the drain to a drain pit or septic system. Unlike regular greensand systems, no permanganate powder is required.

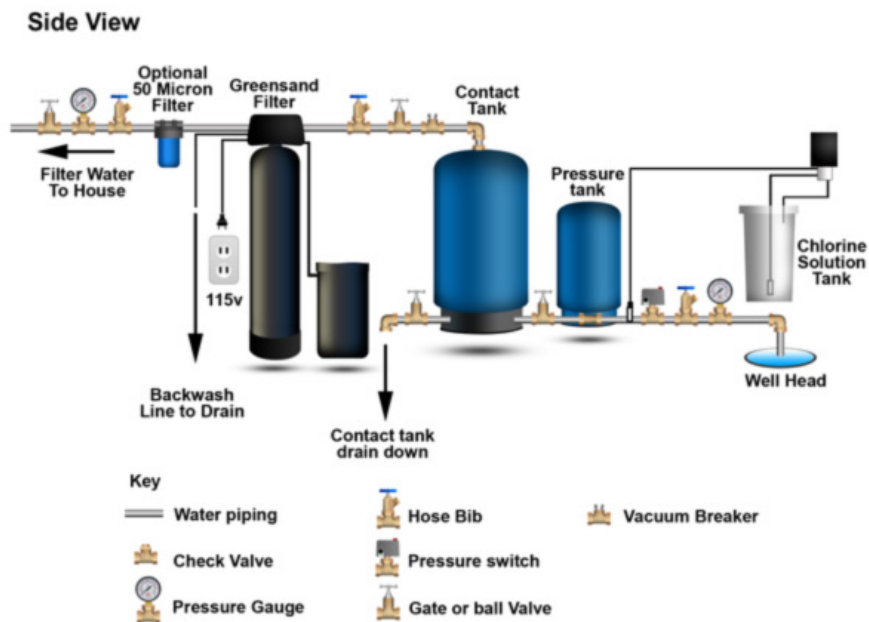

23. Ozone Treatment

There are two common methods for injecting ozone into water. In the first method, an open holding tank of at least a 200-gallon capacity is used. Larger holding tanks up to 5000 gallons work better. A compressor or blower is set up on a timer, or wired in so that when the well pump runs, the ozone blower system runs. The air compressor is hooked up to a ceramic diffuser stone, creating a large volume of tiny air bubbles.

When using ozone, chlorine, or hydrogen peroxide, the contact time & concentration of the chemical is critical.



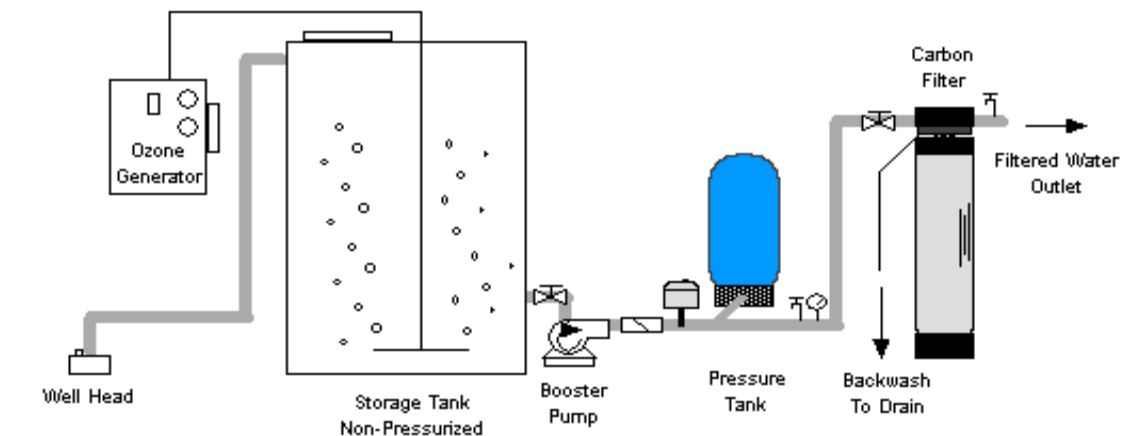

If sufficient air is used, and the hydrogen sulfide levels are low, this method combined with periodic shock chlorination works well. Shock chlorination is required to keep the levels of bacteria down in the well and holding tank.

Ozone Bubble Type System

Ozone Bubbler in Storage Tank + Carbon Filter
Flow Diagram Not to scale



Key

-  Gate or ball valve
-  Pressure gauge
-  Hose bib
-  Pressure Switch
-  Check Valve

Notes: Well pump is controlled by a float switch in holding tank. When water level in tank drops to a preset level, well pump and ozone generator turn on. As water is pumped from the well into the storage tank, the ozone generator bubbles ozone gas into the tank through ceramic diffuser stones. Precipitated oxidized particles of iron, sulfides and manganese if present are filtered out by the carbon/sand filter. Periodically, the filter backwashes automatically and flushes out the sediment and particulates. Depending on the concentration of ozone gas, the piping should be either Sch80 PVC or stainless steel, and the tank should be made from ozone resistant materials. Follow all local plumbing and electrical codes.

In the open bubbler tank design, a UV-generated ozone system or a higher output corona-discharge ozone generator with air-dryer can be used. The UV-generated ozone systems produce lower concentrations of ozone, but use more aeration and cost less than corona-discharge generators. Aeration and residence time allow hydrogen sulfide gasses to be oxidized and odors eliminated in addition to the water being disinfected if the ozone concentration is sufficient.

Venturi Injection

Ozone can also be injected via a venturi under pressure, which is a more efficient use of ozone. This type of ozone injection usually requires higher concentrations of ozone, and typically a corona-discharge generator with dry air or oxygen feed gas is used. A venturi injector allows much more of the ozone to mix with the water than with a bubbler system so it is a more efficient use of the ozone gas.

It is possible to use a venturi-type ozone system directly on a well system, but usually the pressure loss is too great and so a contact tank with its own recirculating booster pump is used to drive water through the injector and draw in the ozone gas.

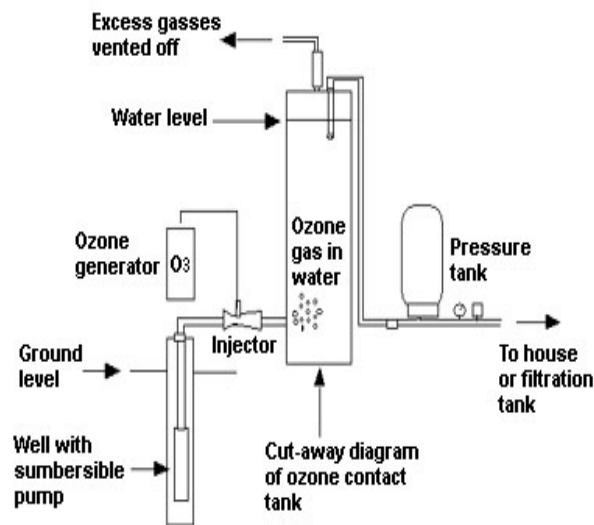

Clear Water Tech brand Ozone venturi and contact with booster pump

Usually, after either type of ozone injection, filtration is required. Depending on the water chemistry, filtration by greensand, sand and anthracite, or activated carbon filters is used. These types of filters are periodically backwashed to keep the media clean and free of trapped sulfides, iron, or manganese oxides.

How to Size Ozone Generators

When using ozone to oxidize iron, eliminate odor, or disinfect water, the amount of ozone required in grams per hour must be calculated. Ozone generators are sized by their output in grams per hour. Note that these calculations are for a single pass through system.

Ozone Demand Calculations: $\text{gr. /hr.} = \text{L/hr.} \times \text{O3D}$, where gr. /hr. = Grams of ozone per hour and L/hr. = Liters per hour flow rate to be treated. There are four steps in calculating grams per hour of ozone:

1. The first step is to figure the flow rate in L/hr. If the flow rate is in gallons per minute it must be converted to L/hr. multiply the rate by 60 to get gallons per hour and then multiply that figure by 3.785 to get the equivalent flow in L/hr.
2. Next determine contaminant demand on ozone by multiplying the mg/L of each contaminant found in the source and adding 0.5 mg/L for disinfection and adding it all together.

$$\text{Iron demand} = \text{X } 0.43 = \text{mg/L}$$

$$\text{Manganese demand} = \text{X } 0.87 = \text{mg/L}$$

$$\text{Hydrogen Sulfide demand} = \text{X } 3.0 = \text{mg/L}$$

$$\text{Sum total} = \text{mg/L} = \text{mg/L (O3) demand} = \text{O3D}$$

3. Multiply the O3D by L/hr. to calculate mg/L of ozone required.
4. Divide by 1,000 to convert to grams per hour needed to treat the water.

Example Calculation: As an example we can consider for these calculations that it contains 2.0 mg/L Fe; the Mn is 0.4 mg/L; and 2 mg/L of hydrogen sulfide; and 1 mg/L for disinfection. The flow rate is 10 gallons per minute.

$$10 \text{ gpm} \times 60 \times 3.785 = 2271 \text{ L/hr.}$$

$$2.0 \text{ Fe mg/l} \times 0.43 = 0.86 \text{ mg/L} \quad + 0.4 \text{ mg/L Mn} \times 0.87 = 0.35 \text{ mg/L}$$

$$+ 2 \text{ mg/L} \times 3.0 \text{ mg/L} = 6 \text{ mg/L} \quad + 1 \text{ mg/L for disinfection}$$

$$0.86 + 0.35 + 3.0 + 1.0 = 5.21 \text{ mg/L O3D}$$

$$2271 \text{ L/hr.} \times 5.21 = 11831 \text{ mg/hr.}$$

$$11831 \text{ divided by } 1,000 = 11.83 \text{ gr. /hr. (12 grams/hour). Total ozone demand}$$

24. Ultraviolet Sterilizers

Ultraviolet sterilizers can be an alternative method of disinfection under the right conditions. Ultraviolet sterilizers work by exposing the cell walls of organisms to intense UV light, disrupting the genetic material and preventing the organism from reproducing. UV effectively destroys bacteria and viruses but is limited by the clarity of the water, and only works on water that is clear and has a high UV transmission rate. Unlike chlorine there is no downstream residual disinfection. Pretreatment for iron, sediment and minerals of excessive hardness is recommended. UV is advantageous because it is:

Effective - virtually all microorganisms are susceptible to ultraviolet disinfection.

Economical - hundreds of gallons are purified for each penny of operating cost.

Safe - no danger of overdosing, no addition of chemicals.

Fast - water is ready for use as soon as it leaves the purifier – no further contact time required.

Easy - simple installation and maintenance. Compact units require minimum space.

Automatic - provides continuous disinfection without special attention or measurement.



Ultraviolet sterilizer

24.1 Factors Affecting UV Treatment

Water to be treated by UV light should be clear and relatively low in minerals:

- Water should be low in hardness minerals: Less than 7 grains per gallon of hardness, or less than 120 PPM)
- Water should be free of color
- Iron should be less than 0.3 mg/L.
- Manganese should be less than 0.05 mg/L
- pH range should be 6.5 to 9.5

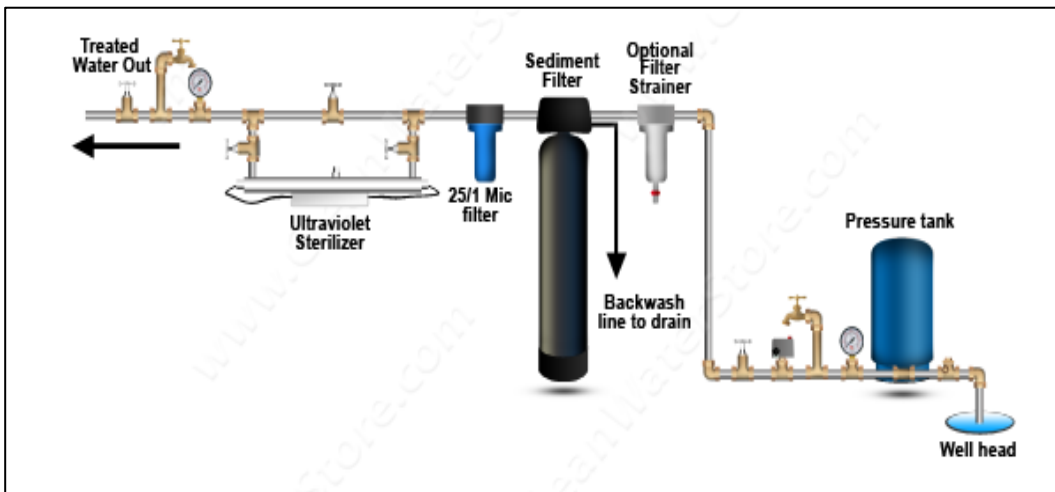

Water to be treated by UV light should be clear and relatively low in minerals. If the water is hard (over 5 – 10 grains per gallon of hardness) a water softener is recommended to remove the hardness. If the water is cloudy or high in turbidity, it is essential to treat the water prior to treating with UV light.

The UVT or UV Transmission level should be low enough to allow the UV rays to penetrate the water. A 5 micron filter for pretreatment is recommended as a minimum precaution.

UV dosage is measured in microwatt-seconds per square centimeter area. From these units, it can be seen that UV dosage is a function of UV intensity (microwatts) and time (seconds). The industry standard of recommended UV dosage is $30\text{mJ}/\text{cm}^2$ $30,000\ \mu\text{Wt-secs}/\text{cm}^2$. This dosage is sufficient for most water-borne pathogens — 99.99 percent of E. coli will be removed with a dosage of $6\text{-}10\text{mJ}/\text{cm}^2$. UV sterilizers are sized in gallons per minute, in order to properly dose the water with the minimum UV dosage of $30\text{mJ}/\text{cm}^2$ $30,000\ \mu\text{Wt-secs}/\text{cm}^2$.

By following the recommended maximum gallons per minute, and assuring the water is properly pre-treated, the UV system will perform properly.

24.2 Routine Testing

Water should be tested for coliform bacteria on a regular basis. Home test kits are available that can show if coliform is present or not. Regular testing at a licensed laboratory is recommended to verify the UV system is working properly.

24.3 Pretreatment System for Hard Water

Softener > 25/1 Dual-Grade Filter > UV Sterilizer

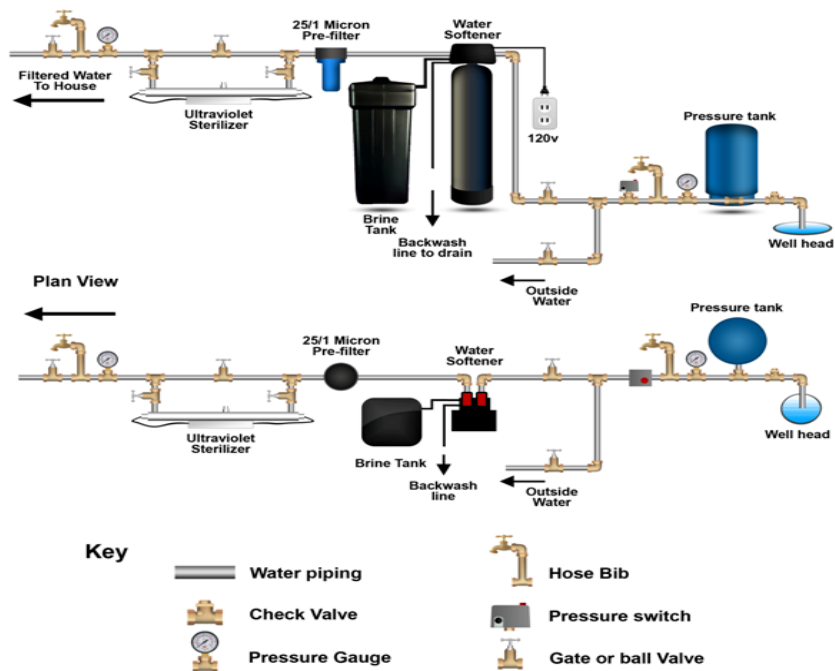

24.4 Pretreatment for Sediment

Sediment Backwash Filter > 25/1 Dual-Grade Filter > UV

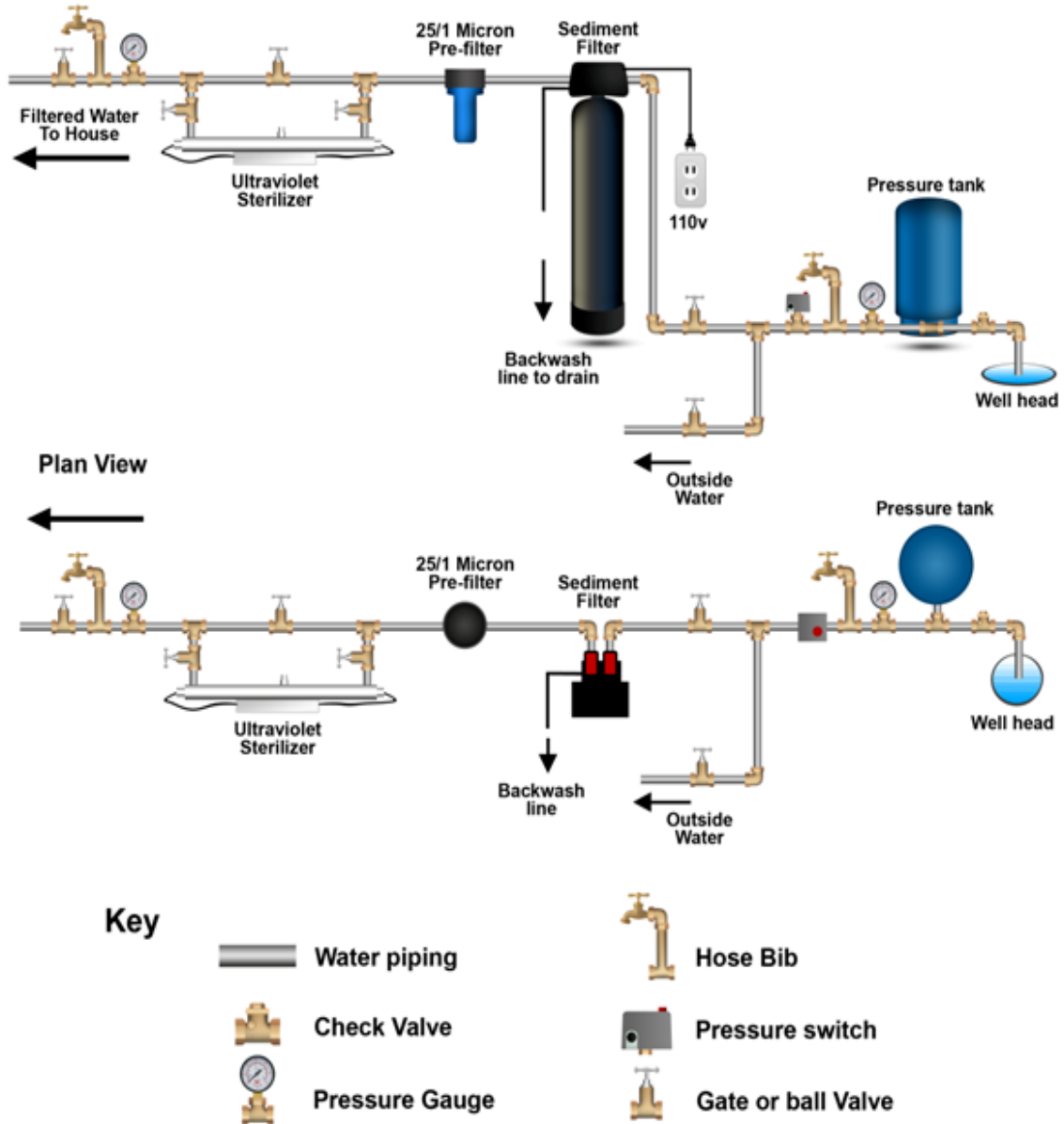

24.5 Pretreatment for Iron in Well Water

Iron Filter > 25/1 Dual Grade Filter > UV Sterilizer

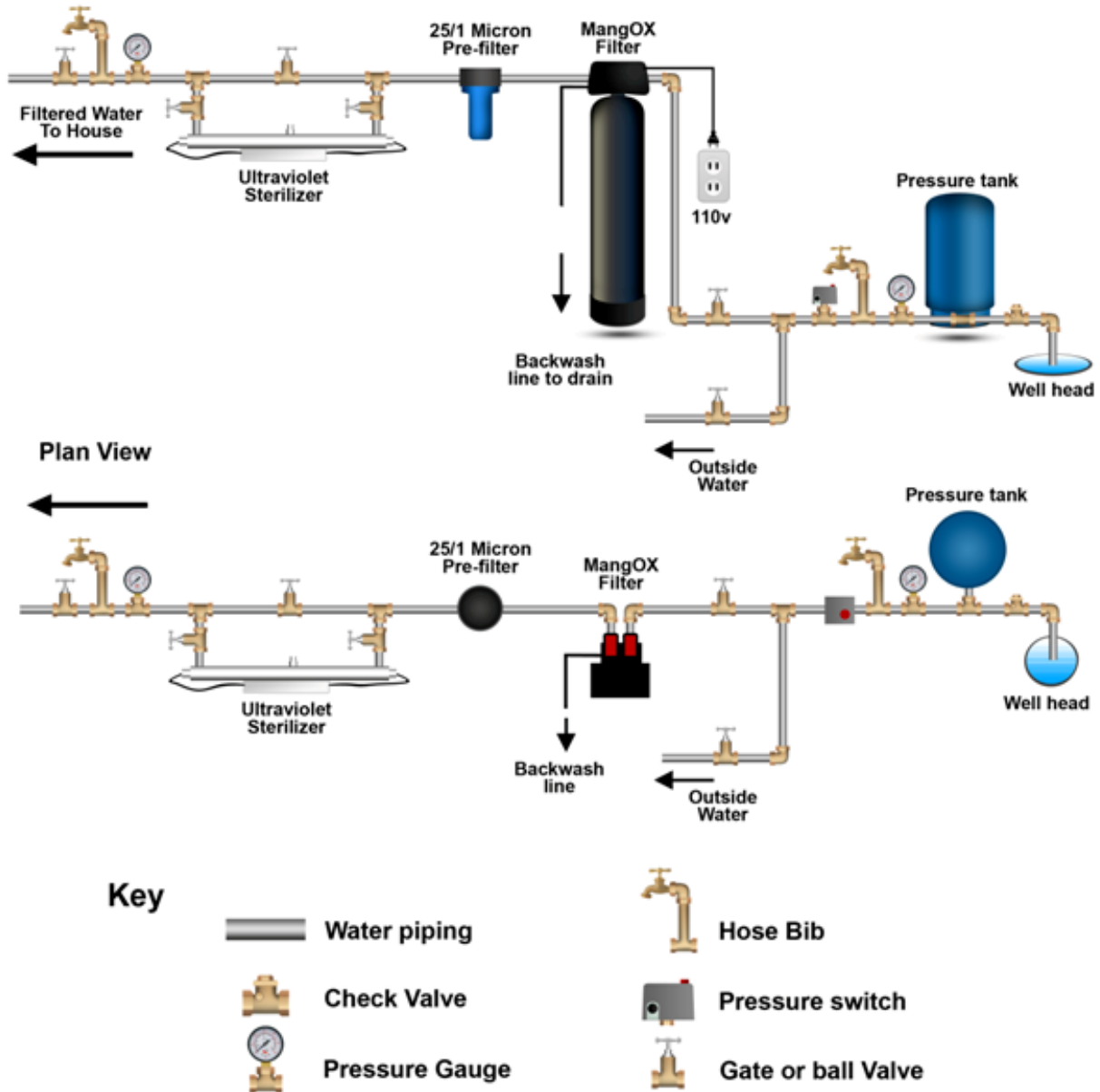

24.6 Ultraviolet Sterilizers and Giardia

Cryptosporidium and *Giardia* protozoa are present in many drinking water supplies across the world. The occurrence of *Cryptosporidium parvum* in drinking water sources is recognized as a significant threat to private and public water supplies throughout the world (Rose *et al.*, 1991; Lisle and Rose, 1995; Messner and Wolpert, 2000).

Water treatment plants usually cannot guarantee the removal of all *Cryptosporidium* because these tiny parasites are formed as cysts, called oocysts and are very small (four to five micrometers in diameter). They are resistant to chlorine and most other disinfectants. It is for this reason that many municipal treatment plants are installing UV systems.

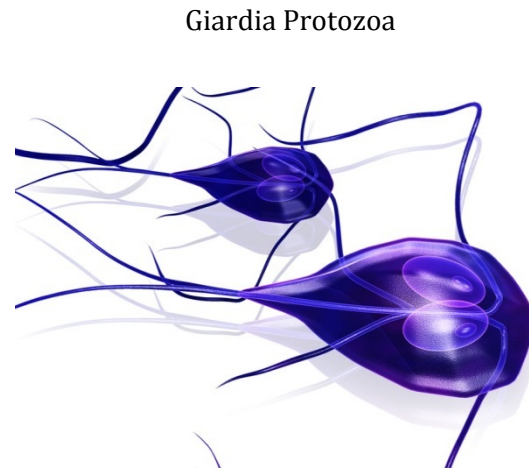

In Canada and the US, 60.2 percent of surface water samples contained oocysts in a study done by LeChevallier and Norton in 1995. But a report published by the US EPA indicates that, "...*Cryptosporidium* is not only a surface water problem."

The same report also mentions a study done by Hancock *et al.* (1998), reporting a study of 199 ground water samples tested for *Cryptosporidium*. They found that five percent of vertical wells, 20 percent of springs, 50 percent of infiltration galleries, and 45 percent of horizontal wells contained *Cryptosporidium* oocysts. The significance of this is that normal water testing does not test ground waters for oocysts.

An absolute 1 micron filter, combined with UV is effective at removing the oocysts and disinfecting surface and ground water supplies. When UV is used for surface water disinfection or in wells under the influence of surface water, a pre-filter system consisting of 5 micron and then 1 micron absolute filtration is recommended.

Ultraviolet [disinfection](#) of water consists of a purely physical, chemical-free process. UV-C radiation in particular, with a wavelength in the 240 nm to 280 nanometers range, attacks the vital [DNA](#) of the [bacteria](#) directly.

The radiation initiates a photochemical reaction that destroys the genetic information contained in the DNA. The bacteria lose their reproductive capability and are destroyed. Even [parasites](#) such as [Cryptosporidia](#) or [Giardia](#), which are extremely resistant to chemical disinfectants, are efficiently reduced. ^[12] UV can also be used to remove chlorine and chloramine species from water; this process is called photolysis, and requires a higher dose than normal disinfection.

For best results, combine UV sterilizer with an absolute 1 micron filter, or a finer filter such as Ultra-Filtration or Reverse Osmosis. Install the UV sterilizer as a final stage, after pre-treatment and filtration and/or softening.

24.7 Microorganisms That Are Treated By UV

Bacteria	UV Dose	Bacteria	UV Dose
<i>Agrobacterium lumefaciens</i> 5	8,500	<i>Pseudomonas aeruginosa</i> (Environ.Strain)	10,500
<i>Bacillus anthracis</i> 1,4,5,7,9 (anthrax veg.)	8,700	<i>Pseudomonas aeruginosa</i> (Lab. Strain) 5,7	3,900
<i>Bacillus anthracis</i> Spores (anthrax spores)*	46,200	<i>Pseudomonas fluorescens</i> 4,9	6,600
<i>Bacillus megatherium</i> Sp. (veg) 4,5,9	2,500	<i>Rhodospirillum rubrum</i> 5	6,200
<i>Bacillus megatherium</i> Sp. (spores) 4,9	5,200	<i>Salmonella enteritidis</i> 3,4,5,9	7,600
<i>Bacillus paratyphosus</i> 4,9	6,100	<i>Salmonella paratyphi</i> (Enteric Fever) 5,7	6,100
<i>Bacillus subtilis</i> 3,4,5,6,9	11,000	<i>Salmonella Species</i> 4,7,9	15,200
<i>Bacillus subtilis</i> Spores 2,3,4,6,9	22,000	<i>Salmonella typhimurium</i> 4,5,9	15,200
<i>Clostridium tetani</i>	23,100	<i>Salmonella typhi</i> (Typhoid Fever) 7	7,000
<i>Clostridium botulinum</i>	11,200	Salmonella	10,500
<i>Corynebacterium diphtheriae</i> 1,4,5,7,8,9	6,500	<i>Sarcina lutea</i> 1,4,5,6,9	26,400
Dysentery bacilli 3,4,7,9	4,200	<i>Serratia marcescens</i> 1,4,6,9	6,160
<i>Eberthella typhosa</i> 1,4,9	4,100	<i>Shigella dysenteriae</i> - Dysentery 1,5,7,9	4,200
<i>Escherichia coli</i> 1,2,3,4,9	6,600	<i>Shigella flexneri</i> - Dysentery 5,7	3,400
<i>Legionella bozemanii</i> 5	3,500	<i>Shigella paradysenteriae</i> 4,9	3,400
<i>Legionella dumoffii</i> 5	5,500	<i>Shigella sonnei</i> 5	7,000
<i>Legionella gormanii</i> 5	4,900	<i>Spirillum rubrum</i> 1,4,6,9	6,160
<i>Legionella micdadei</i> 5	3,100	<i>Staphylococcus albus</i> 1,6,9	5,720
<i>Legionella pneumophila</i> (Legionnaire's Disease)	12,300	<i>Staphylococcus epidermidis</i> 5,7	5,800
<i>Leptospira canicola</i> -Infectious Jaundice 1,9	6,000	<i>Streptococcus faecalis</i> 5,7,8	10,000
<i>Leptospira interrogans</i> 1,5,9	6,000	<i>Streptococcus hemolyticus</i> 1,3,4,5,6,9	5,500
<i>Micrococcus candidus</i> 4,9	12,300	<i>Streptococcus lactis</i> 1,3,4,5,6	8,800
<i>Micrococcus sphaeroides</i> 1,4,6,9	15,400	<i>Streptococcus pyrogenes</i>	4,200

<i>Mycobacterium tuberculosis</i> 1,3,4,5,7,8,9	10,000	<i>Streptococcus salivarius</i>	4,200
<i>Neisseria catarrhalis</i> 1,4,5,9	8,500	<i>Streptococcus viridans</i> 3,4,5,9	3,800
<i>Phytomonas tumefaciens</i> 1,4,9	8,500	<i>Vibrio comma</i> (Cholera) 3,7	6,500
<i>Proteus vulgaris</i> 1,4,5,9	6,600	<i>Vibrio cholerae</i> 1,5,8,9	6,500
Molds	UV Dose	Molds	UV Dose
<i>Aspergillus amstelodami</i>	77,000	<i>Oospora lactis</i> 1,3,4,6,9	11,000
<i>Aspergillus flavus</i> 1,4,5,6,9	99,000	<i>Penicillium chrysogenum</i>	56,000
<i>Aspergillus glaucus</i> 4,5,6,9	88,000	<i>Penicillium digitatum</i> 4,5,6,9	88,000
<i>Aspergillus niger</i> (bread mold) 2,3,4,5,6,9	330,000	<i>Penicillium expansum</i> 1,4,5,6,9	22,000
<i>Mucor mucedo</i>	77,000	<i>Penicillium roqueforti</i> 1,2,3,4,5,6	26,400
<i>Mucor racemosus</i> (A & B) 1,3,4,6,9	35,200	<i>Rhizopus nigricans</i> (cheese mold) 3,4,5,6,9	220,000
Protozoa	UV Dose	Protozoa	UV Dose
<i>Chlorella vulgaris</i> (algae) 1,2,3,4,5,9	22,000	<i>Giardia lamblia</i> (cysts) 3	100,000
Blue-green Algae	420,000	Nematode Eggs 6	40,000
<i>E. hystolytica</i>	84,000	Paramecium 1,2,3,4,5,6,9	200,000
Virus	UV Dose	Virus	UV Dose
Adeno Virus Type III 3	4,500	Influenza 1,2,3,4,5,7,9	6,600
Bacteriophage 1,3,4,5,6,9	6,600	Rotavirus 5	24,000
Coxsackie	6,300	Tobacco Mosaic 2,4,5,6,9	440,000
Infectious Hepatitis 1,5,7,9	8,000		
Yeasts	UV Dose	Yeasts	UV Dose
Baker's Yeast 1,3,4,5,6,7,9	8,800	<i>Saccharomyces cerevisiae</i> 4,6,9	13,200
Brewer's Yeast 1,2,3,4,5,6,9	6,600	<i>Saccharomyces ellipsoideus</i> 4,5,6,9	13,200
Common Yeast Cake 1,4,5,6,9	13,200	<i>Saccharomyces sp.</i> 2,3,4,5,6,9	17,600

25. Chlorinators

25.1 How to Select and Size a Chlorinator Feed Pump

Many residential water wells require a chlorine bleach feed pump also known as a chlorinator, to kill bacteria, eliminate odors, pre-treat the water for iron removal, or to treat iron bacteria.

Common household bleach can be used in an automatic chlorinator system to kill coliform bacteria and provide disinfected water. In some wells, iron or sulfur bacteria can create 'rotten egg' odors and cause staining of fixtures and appliances. Chlorinators can also be used to address these problems.

The first step in selecting a chlorinator is to find out your basic water chemistry and have your well water tested. A general mineral analysis will provide a list of the common minerals (calcium, magnesium, iron, manganese, dissolved solids), alkalinity, and pH. The pH is important to note, because more chlorine is required for water with a higher pH level.

25.2 How Much Chlorine Should I Plan to Add?

Chlorine is injected in parts per million (PPM) which is the same as saying milligrams per liter (mg/L). For bacteria, you want 1 – 2 PPM of chlorine and approximately 10 minutes of contact time. You may need longer contact time if the water is colder than 50°F (10°C) and/or the pH is higher than 7.5.

For each part per million of iron or manganese you want to inject 1 PPM of chlorine. For each PPM of hydrogen sulfide gas, you want to inject 2 to 3 PPM of chlorine.

Assume you have bacteria and 2.0 PPM of iron: you should plan to inject about 3 PPM of chlorine.

25.3 How Do I Know What Size Chlorinator Pump to Install?

The next step in selecting your metering pump is to know at how many gallons per minute your well water is flowing at the point where you will be injecting the chlorine. Usually the best place to inject the chlorine is before the pressure tank. Unless you have a variable-speed pump, your water at this point is flowing at approximately the same flow rate every time the well pump turns on. After you use up the reserve in the pressure tank, the pressure switch turns on the well pump and the water begins to flow from the well.

You can easily calculate the flow rate at this point by following these steps:

1. Open any hose bib or faucet until pump turns on.
2. Close hose bib or faucet and let pump fill up pressure tank until it turns off.
3. Using a 1 or 5 gallon-bucket open faucet, collect and measure all water discharged until pump turns on. Let us say this amount is 20 gallons.

4. When pump turns on, immediately close faucet and start timing pump cycle.
5. When pump turns off, record pump cycle time to refill pressure tank in seconds. Let us say this figure is two minutes or 120 seconds.
6. Divide the number of gallons collected in Step 3 by the number of seconds in Step 5. 20 divided by 120 is 0.166
7. Multiply the answer from Step 6 by 60, which comes out to 10.
8. The answer in Step 7 is the average pumping capacity of the pump in gallons per minute (GPM).

Now that you know the amount of chlorine you want to install (3 PPM) and the flow rate of the water stream you are injecting the chlorine into (10 gallons per minute) you are finally ready to calculate the size of the metering pump.

25.4 How to Size the Chlorine Metering Pump

Metering pumps are often rated by the amount of chlorine solution they can pump in gallons per day, or by the amount of solution they can pump per hour. They have adjusting knobs so you can pump the full output or turn the pump down to deliver up to 90% less than the output. Turned up all the way the pump puts out 100% of its output, or you can adjust it down to some percentage less than 100%.

The formula is simple: multiply the flow of the water in gallons per minute (GPM) by the applied dosage in parts per million (PPM), and then multiply this by 1440 (the number of minutes in one 24 hour period). Finally, divide this number by the solution strength being used.

$10 \text{ GPM} \times 3.0 \text{ PPM} \times 1440 \text{ divided by } 5000 = 8.6 \text{ gallons per day}$

At this rate you can select a metering pump that can pump 10 gallons per day and adjust the output of the pump to 86% to achieve the desired 8.6 gallons per day. Finally you can test the chlorine residual at the kitchen sink. Your goal should be to have a residual of 0.2 to 0.8 PPM of chlorine.





If you find the residual is too high, you can adjust the metering pump down to deliver less or dilute the chlorine solution with more water. If you find the residual is too low, you can make the solution strength stronger by using less water to dilute the solution, or you can turn up the output of the metering pump.

With metering pumps, liquid chlorine (bleach) is injected right out of the well, before the pressure tank. Often a contact tank is used to allow sufficient contact time.

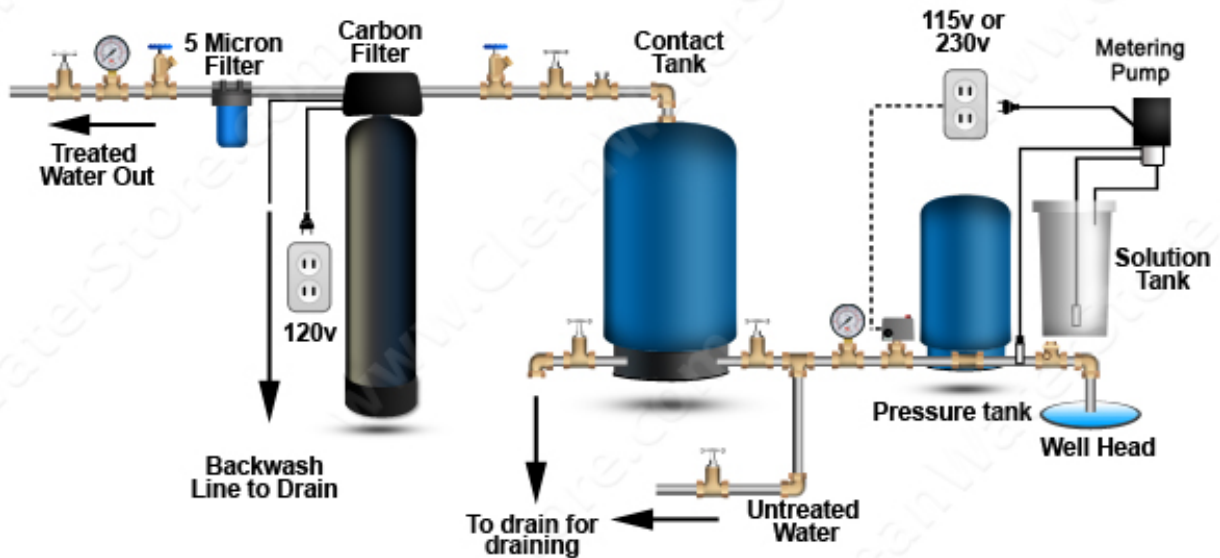
Below is a typical installation of a chlorine bleach pump injector, on a standard well pump and pressure tank. Also see proportional feed chlorinators for installing the injector after the pressure tank, or if the well has a variable speed well pump.

Chlorine metering pump turned on and off by wiring into same circuit as the well pump



-  Gate or ball valve
-  Pressure gauge
-  Hose bib
-  Pressure Switch
-  Check Valve

Notes: The well pump is controlled by the pressure switch. When pressure in pressure tank drops below the cut-in point on the pressure switch the well pump and metering pump turn on. As water is pumped through the system, a small amount of chlorine is pumped into the water by the chlorine metering pump. As the water flows into the contact tank, the chlorine is thoroughly mixed in the water, allowing contact time to kill bacteria and oxidize any iron, manganese or hydrogen sulfide gas. Precipitated oxidized particles of iron, sulfides and manganese are not filtered out and a filtration system may be required. Follow all local plumbing and electrical codes.

Chlorine metering pump turned on and off by a flow switch:

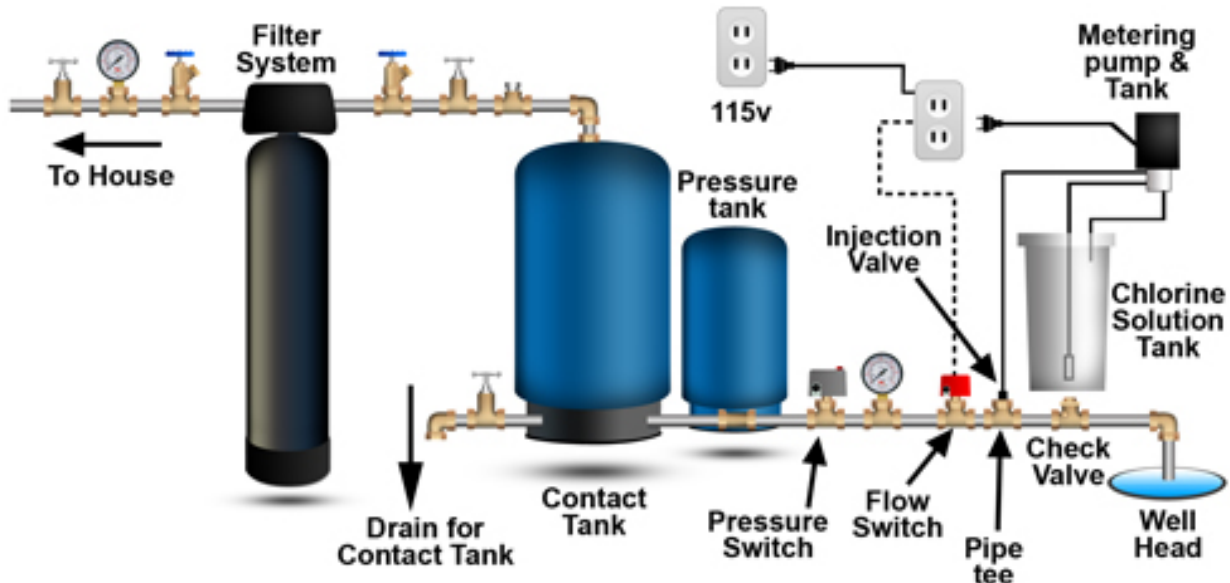

Chlorine metering pump controlled by a flow meter: This type measures the amount of water being used and allows the chlorine metering pump to pump more or less chlorine, based on usage. This type can be installed at the point of entry to the house, after the pressure tank.

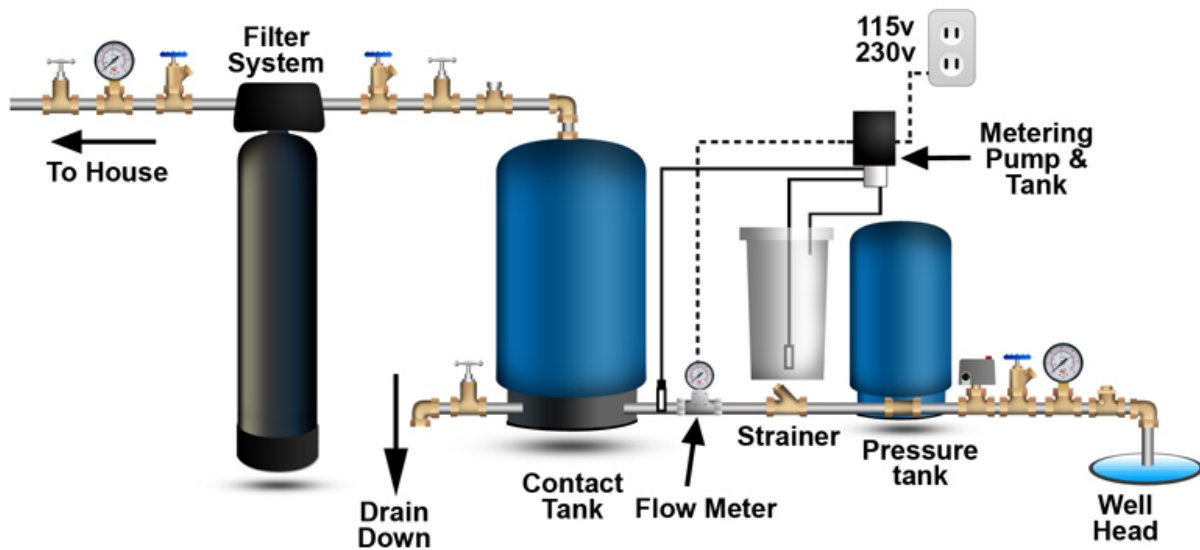

Oxidizer Comparison Chart

Iron, manganese and hydrogen sulfide are usually found dissolved in water. By introducing an oxidizer such as ozone, chlorine, hydrogen peroxide or oxygen the iron and manganese can be oxidized to a solid form, which can then be filtered out. You can see from the chart below that it only takes 0.5 to 1.0 mg/L of ozone to oxidize 1 mg/L of iron, where as it takes 1.7 to 2.0 mg/l of chlorine to have the same effect.

Theoretical Amounts of Various Agents Required to Oxidize 1 mg/L of Manganous Ion to MnO(O H₂)

Oxidizing Agent	Practical Amount Required to Oxidize 1 mg/L Mn ²⁺ (mg/L)	Theoretical Stoichiometry(mg/L)
Ozone	0.5 to 1.0	0.87
Chlorine(Cl ₂)	1.7 to 2.0	1.28
Potassium Permanganate	2.0 to 2.7	1.91
Chlorine Dioxide ClO ₂	2.4 to 3.0	2.46
Hydrogen Peroxide	0.8 to 1.0	0.6
Oxygen	2.5 to 3.3	0.29

Theoretical Amounts of Various Agents Required to Oxidize 1 mg/L of Sulfide Ion

Oxidizing Agent	Practical Amount Required to Oxidize 1 mg/L Mn ²⁺ (mg/L)	Theoretical Stoichiometry(mg/L)
Ozone	2.2 to 3.6	1.5
Chlorine(Cl ₂)	2.0 to 3.0	2.2
Potassium Permanganate	4.0 to 6.0	3.3
Chlorine Dioxide ClO ₂	7.2 to 10.8	4.2
Hydrogen Peroxide	1.0 to 1.5	1.1
Oxygen	2.8 to 3.6	0.5

Comparison of Percentages of Active Halogen Forms

<u>Bromine</u>		pH	<u>Chlorine</u>	
Percent as (Obr)	Percent as HOBr		Percent as HOCl	Percent as (OCl)
4	96	7.2	66	34
6	94	7.5	48	52
13	87	7.8	33	67
17	83	8.0	22	78

26. Hydrogen Peroxide Systems

26.1 How Hydrogen Peroxide Systems Work

Hydrogen peroxide treatment of water is becoming increasingly popular as an alternative to chlorination of water. When hydrogen peroxide is injected into water, a large amount of dissolved oxygen is released and a strong oxidizing effect takes place. Odors are eliminated, microorganisms are destroyed, and tannins are oxidized.

Advantages of Hydrogen Peroxide:

1. Works faster than chlorine, so often no contact tank is required
2. Unlike chlorine will not leave a chemical residual in the water
3. Peroxide works over a wider pH range

Like chlorine, [hydrogen peroxide is a strong oxidizer and can quickly](#) eliminate the odors. Unlike chlorine however, hydrogen peroxide leaves behind no trace of chemical by-products.

For peroxide, a peristaltic metering pump or a diaphragm pump with a degassing works best to inject a precise dosage of peroxide. The metering pump (sometimes called a 'dosing pump') can be adjusted up or down, and a simple test kit can tell you quickly if you are achieving the proper dosage.

The well pump is controlled by the pressure switch. A dedicated outlet for the metering pump is installed and wired so it is energized when the well pump is energized. When the water pressure in the pressure tank drops below the cut-in point on the pressure switch, the well pump and metering pump turn on. As water is pumped through the system, a small amount of hydrogen peroxide is pumped into the water by the metering pump. The contact is optional and not necessary for many applications.

Fig. 1: Typical installation with contact tank and carbon backwash filter. Note that contact tank is optional and is not required for all applications.

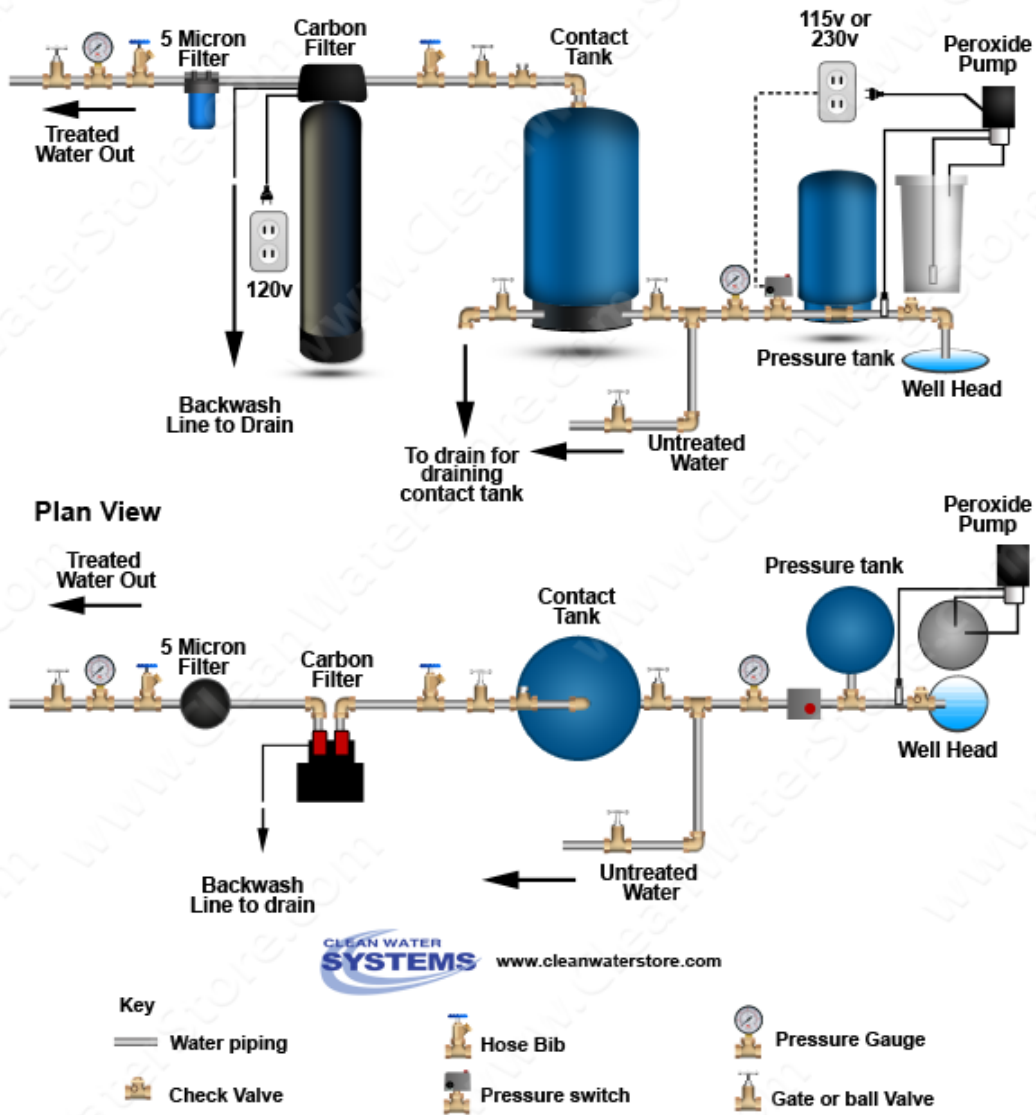

26.2 Peroxide Installation

Typically a peristaltic type metering pump, or a diaphragm pump with a degassing valve is used with peroxide.

The optional contact tank allows for disinfection of bacteria, as well as oxidation and removal of iron and odors.

As the water flows into the contact tank, the hydrogen peroxide is thoroughly mixed in the water, allowing contact time to kill bacteria and oxidize iron, or hydrogen sulfide gas. Precipitated oxidized particles of iron are filtered out of the water by the backwash filter, which is typically a catalytic carbon media filter type system.

Adjust the peristaltic pump and the solution strength so there is a peroxide residual of 0.2 to 0.4 ppm after the contact tank before filtration.

Regarding optional vacuum breaker: the contact tank can withstand a line pressure of 75 PSI, but cannot take any vacuum. If the contact tank is drained or if the well system loses pressure, and water accidentally drains back down the well, or is drained after contact tank and a hose bib or faucet is not opened to allow air into the tank, a vacuum may occur inside the tank. This will cause contact tank failure, so a small 1/2" or 3/4" vacuum breaker is recommended to prevent this rare occurrence.

Follow all local plumbing and electrical codes.

26.3 Selecting Hydrogen Peroxide Solution Strength & Pump Settings

The goal of a properly functioning hydrogen peroxide injection system is to have a peroxide residual of 0.2 to 0.6 ppm after sufficient contact time, before any carbon filter system. A hydrogen peroxide test kit can be easily used to measure the amount of peroxide in the water. Hydrogen peroxide acts rapidly and often no contact tank is needed for iron and odor removal, although having the contact tank insures the water is disinfected of bacteria as well.

It is not a good practice to have a measureable peroxide residual in your household plumbing.

For most residential applications, we do recommend a carbon or other filter system that will break down the peroxide into oxygen and water, so no peroxide is in the final water being used for drinking or bathing. However, peroxide will break down without any carbon or other filtration if there is sufficient time between injection and use of the water.

You can reach your desired peroxide level by adjusting the hydrogen peroxide solution strength and settings on the peroxide pump until you achieve the desired residual.

In determining your metering pump's settings and solution strength, keep in mind that it is best to make up fresh solution once every 2 to 3 months. The hydrogen peroxide solution loses strength as it ages, and is sensitive to heat and light. Thus, you should keep your solution tank out of the sun and use fresh solution regularly for best results.

***Step One:** Determine flow rate (in gallons per minute) of water stream into which you are injecting*

1. Open any hose bib or faucet until pump turns on.
2. Close hose bib or faucet and let pump fill up pressure tank until it turns off.
3. Using a 1 or 5 gallon bucket, open faucet and collect and measure all water discharged until pump turns on.
4. When pump turns on, immediately close faucet and start timing pump cycle.
5. When pump turns off, record pump cycle time to refill pressure tank in seconds.
6. Divide the number of gallons collected in Step 3 by the number of seconds in Step 5.
7. Multiply the answer from Step 6 by 60.
8. The answer in Step 7 is the average pumping capacity of the pump in gallons per minute (GPM).

***Step Two:** How much hydrogen peroxide should be injected? Determine concentration of hydrogen peroxide you are trying to achieve in parts per million.*

Hydrogen peroxide is injected in parts per million (ppm) which is the same as saying milligrams per liter (mg/L). The amount of hydrogen peroxide needed depends on the "hydrogen peroxide demand" of the water. Hydrogen peroxide demand is the amount of various contaminants in the water that combine with the hydrogen peroxide after the hydrogen peroxide has been injected and sufficient contact time has occurred.

After the hydrogen peroxide has combined with the various contaminants such as bacteria, iron, manganese, and odor, some level of uncombined or "free" hydrogen peroxide will remain. The goal is to have some small amount of peroxide, usually around 0.2 to 0.4 ppm of peroxide, up to a maximum of 1.0 ppm of hydrogen peroxide, before filtration.

For bacteria you'll want to inject 1 – 2 ppm of hydrogen peroxide with approximately 5 to 10 minutes of contact time depending on your water's temperature and turbidity (cloudiness). If the water is colder than 50° F (10° C) and/or the pH is higher than 7.5, you may need longer contact time or a higher residual.

You should generally inject 1.0 ppm of hydrogen peroxide for each part per million of iron. For each 1.0 ppm of hydrogen sulfide gas (which causes the rotten egg smell in water) you should inject 1 to 2 ppm of hydrogen peroxide.

Note: Peroxide is NOT effective for oxidizing manganese. It is not recommended to use peroxide when manganese is present. Manganese is better oxidized with chlorine or ozone.

Also, note that peroxide is a very weak biocide and not recommended for killing pathogenic organisms such as coliform or e-coli. The USEPA states that “Hydrogen peroxide (H₂O₂) is rarely used in drinking water treatment as a stand-alone treatment process. H₂O₂ is a weak micro-biocide compared to chlorine, ozone, and other commonly used disinfectants. Consequently, it is not approved by regulatory agencies as a stand-alone disinfection treatment process.”

Step Three: Determine what solution strength of peroxide to use

Assume you are using a peroxide solution of 7%. This means that this solution contains 7% active hydrogen peroxide. 7% peroxide is equal to 70,000 parts per million (PPM). Note that for most applications the peroxide can be injected without diluting the solution. The solution strength required depends on the flow rate of the water you are injecting into, and the applied dosage you want to inject.

If you dilute the peroxide by adding 1 gallon of softened or purified water to 1 gallon of household peroxide, you end up with solution strength of approximately 3.5% or 35,000 ppm. In other words, 7% peroxide has solution strength of 70,000 ppm, and if you dilute it with 1 gallon of water, you end up with solution strength of 35,000 ppm.

You can vary the applied dosage of hydrogen peroxide **by adjusting the peroxide solution strength and setting the metering pump feed rate control knob until you achieve the desired residual.**

Next, use the formula below to compute the gallons per day to adjust the pump to end up with the desired applied dosage.

The formula is simple:

$$\text{(Flow Rate (in gallons per minute) x Applied Dosage (in parts per million) x 1440) / Solution Strength (PPM)}$$

Example: Assume that you have a well pump that has a flow rate of 12 gallons per minute (12 GPM) and that you want to inject 5.0 ppm of hydrogen peroxide into the water. You have decided to use solution strength of 35,000 ppm or 1 gallon of 7% peroxide to two gallons of purified or at least softened water.

There are 1440 minutes in 24 hour period, and the formula will tell you how many gallons of hydrogen peroxide solution you will use for every 24 hours the well pump runs.

The formula for this example would be:

$$(12 \text{ GPM} \times 5.0 \text{ PPM} \times 1440) \text{ divided by } 70,000 = 2.46 \text{ Gallons Per } 24 \text{ hours of well pump run time}$$

It is good to add more solution every one to two months as the solution can lose its potency over time.

Whatever your initial setting be sure to test for hydrogen peroxide and then adjust the pump and/or the solution strength to achieve your desired peroxide residual in your piping.

26.4 How to Determine Peroxide Residual

If you have no hydrogen peroxide test kit to determine peroxide residual, you can use the Bubble Method:

Turn up the metering pump until you see tiny bubbles when you run a faucet in the house or hose bib after the peroxide system. The presence of tiny bubbles indicates excess peroxide. Turn back the metering pump until the bubbles are not noticeable.

For best results and most accurate analysis, use one of the low cost peroxide titration test kits on the market, such as from Hach or Lamotte, or test strips from Industrial Test Systems.

27. Disinfection and Contact Time

Disinfection is important to ensure that water is safe to drink. Municipal water systems add disinfectants to destroy microorganisms that can cause disease in humans and if your well or home water system contains bacteria or is at risk for bacterial contamination it is important to disinfect your water.

Primary methods of disinfection are chlorination, chloramines, ozone, and ultraviolet light. Other disinfection methods include chlorine dioxide, potassium permanganate, and nano-filtration.

The most common methods of disinfecting well water for home water well are:

- Chlorination
- Ultraviolet Light
- Ozone
- Hydrogen Peroxide
- Chlorine dioxide (not usually used in home water well systems)

For disinfection to occur, proper contact time must occur with the correct dosage of a particular disinfectant. This is referred to as the CT Value. See the charts on the following pages for CT Values for viruses and parasites and note the difference between the CT values.

**The CT Value is the Concentration multiplied by the Time of contact.
Higher concentrations of chlorine or ozone etc are needed if the contact time is less. A longer contact time is desirable. A 3 log removal means 99.9% removal rate.**

**U.S. EPA CT VALUES (mg/L x min) for the Inactivation of Giardia Cysts
with Ozone at Different Temperatures and pH from 6 to 9.¹²**

Inactivation	Temperature °C (°F)					
	0.5(32.1)	5(41)	10(50)	15(59)	20(68)	25(77)
0.5 log	0.48	0.32	0.23	0.16	0.12	0.08
1.0 log	0.97	0.63	0.48	0.32	0.24	0.16
1.5 log	1.50	0.95	0.72	0.48	0.36	0.24
2.0 log	1.90	1.30	0.95	0.63	0.48	0.32
2.5 log	2.40	1.60	1.20	0.79	0.60	0.40
3.0 log	2.90	1.90	1.40	0.95	0.72	0.48

CT Values for Inactivation of Viruses by Ozone¹²

Inactivation	Temperature, °C					
	≤1	5	10	15	20	25
2- log	0.48	0.32	0.23	0.16	0.12	0.08
3- log	0.97	0.63	0.48	0.32	0.24	0.16
4- log	1.50	0.95	0.72	0.48	0.36	0.24

**CT Values for 3-log (99.9%) Inactivation of Giardia Cysts by Free Chlorine at Water
Temperature 10.0 °C (50°F)¹²**

Free Residual, Mg/L	pH						
	≤ 6.0	6.5	7.0	7.5	8.0	8.5	≤ 9.0
≤ 0.4	73	88	104	125	149	177	209
0.6	75	90	107	128	153	183	218
0.8	78	92	110	131	158	189	226
1.0	79	94	112	134	162	195	234
1.2	80	95	114	137	168	200	240
1.4	82	98	116	140	170	206	247
1.6	83	99	119	144	174	211	253
1.8	88	101	122	147	179	215	259
2.0	87	104	124	150	182	221	265
2.2	89	105	127	153	186	225	271
2.4	90	107	129	157	190	230	276
2.6	92	110	131	160	194	234	281
2.8	93	111	134	163	197	239	287
3.0	95	113	137	166	201	243	292

CT Values for Inactivation of Viruses by Free Chlorine¹²

Temperature, °C	Log Inactivation					
	2.0-log		3.0-log		4.0-log	
	pH6-9	pH 10	pH6-9	pH 10	pH6-9	pH 10
0.5	6	45	9	66	12	90
5	4	30	6	44	8	60
10	3	22	4	33	6	45
15	2	15	3	22	4	30
20	1	11	2	16	3	22
25	1	7	1	11	2	15

Note: CT values can be adjusted to other temperatures by doubling the CT for each 10°C drop in temperature.

CT Values for Inactivation of Giardia Cysts by Chloramine Within the pH Range 6 to 9

Inactivation	Temperature, °C					
	≤1	5	10	15	20	25
0.5-log	635	365	310	250	185	125
1-log	1270	735	615	500	370	250
1.5-log	1900	1100	930	750	550	375
2-log	2535	1470	1230	1000	735	500
2.5-log	3170	1830	1540	1250	915	625
3-log	3800	2200	1850	1500	1100	750

CT Values for Inactivation of Viruses by Chloramine

Inactivation	Temperature, °C					
	≤1	5	10	15	20	25
2-log	1243	857	643	428	321	214
3-log	2063	1423	1067	712	534	356
4-log	2883	1988	1491	994	746	497

*This table applies for systems using combined chlorine where chlorine is added prior to ammonia in the treatment sequence.

CT Values for Inactivation of Giardia Cysts by Chloramine Dioxide pH Range 6 to 9

Inactivation	Temperature, °C					
	≤1	5	10	15	20	25
0.5-log	10	4.3	4.0	3.2	2.5	2.0
1-log	21	8.7	7.7	6.3	5.0	3.7
1.5-log	32	13.0	12.0	10.0	7.5	5.5
2-log	42	17.0	15.0	13.0	10.0	7.3
2.5-log	52	22.0	19.0	16.0	13.0	9.0
3-log	63	26.0	23.0	19.0	15.0	11.0

CT Values for Inactivation of Viruses by Chloramine Dioxide pH Range 6 to 9

Inactivation	Temperature, °C					
	≤1	5	10	15	20	25
2-log	8.4	5.6	4.2	2.8	2.1	1.4
3-log	25.6	17.1	12.8	8.6	6.4	4.3
4-log	50.1	33.4	25.1	16.7	12.5	8.4

Amounts of Various Agents Required to Oxidize 1 mg/L of Ferrous Iron²¹

Oxidizing Agent	Practical Amount Required to Oxidize 1 mg/L Fe ⁺² (mg/L)	Theoretical Stoichiometry(mg/L)
Ozone(O ₃)	0.4 to 0.7	0.43
Chlorine(Cl ₂)	0.6 to 1.0	0.63
Potassium Permanganate (KmnO ₄)	0.9 to 2.0	0.94
Hydrogen Peroxide (H ₂ O ₂)	0.3 to 0.5	0.30
Oxygen(O ₂)*	0.86 to 1.1	0.14
Chlorine Dioxide ClO ₂	1.0 to 1.6	1.2

28. Shock Chlorination for Wells

It is important to periodically monitor private water wells to see if contamination is present. The United States Environmental Protection Agency recommends you “test private water supplies annually for nitrate and coliform bacteria to detect contamination problems early. Test them more frequently if you suspect a problem”. www.epa.gov/safewater/pwells1.html

A positive test for Coliform bacteria in a well or home piping system indicates that disease-causing bacteria and viruses are likely to be present. This can mean that the well is under the influence of surface water or septic tanks leaking into the well, or that the well was not properly disinfected after either being drilled or serviced. Other bacteria such as iron and sulfur bacteria, while not a health threat, can produce offensive odors, tastes, and colors, and can cause plugging problems in pump and water systems. Shock chlorination can eliminate the disease-causing bacteria, and other undesired organisms that cause tastes, odors and slime.

Coliform bacteria tests are used as an indicator of the possible presence of disease-causing bacteria. You can test for bacteria yourself using one of our 18-Minute Bacteria test kits, or for a certified test, take the sample to a licensed laboratory in your area. Use a sterile bottle obtained from the laboratory.

Shock chlorination of the well and home piping system is recommended after:

- A new well has been constructed
- Any time a well is opened for repairs
- Floodwater has entered a well
- A new holding tank, pump or pressure tank has been installed
- A new pipeline or other piping or plumbing work has been done
- Tests indicate the presence of coliform bacteria
- Odors or slime caused by iron or sulfur bacteria are present

CAUTION: It is important to remember, while shock chlorination may correct immediate bacteria and/or odor problems in wells and piping systems, it does not correct the source of the bacteria. If bacteria are entering the well from a septic tank or other source, one should correct the problem, otherwise bacteria will redevelop.

How Shock Chlorination Works

Shock chlorination involves introducing a strong chlorine solution (50 to 100 PPM) into the well water and plumbing system, and letting it disinfect the system for 12 to 24 hours.

Don't Use Laundry Bleach

Regular laundry bleach (Clorox etc) has additives that make it work well for cleaning laundry **but is not recommended for potable water sources such as wells**. For well sanitizing you want to use NSF certified liquid bleach or NSF certified chlorine powder or pellets.

If you cannot find either of those locally, then liquid pool chlorine bleach (which is 10% to 12% sodium hypochlorite and has no additives) can be a good substitute. This type of bleach can be found at Home Depot and other hardware stores, or pool supply stores in one gallon jugs and contains only sodium hypochlorite (liquid bleach).

If you use pellets, you want to be sure they are calcium hypochlorite and not "tri-chlor" pellets, which are for pools.

Odors Caused by Bacteria

Often well waters contain odor. Sources of the odor may be from the action of bacteria and sulfates, iron, or manganese. Some waters contain an excessive level of sulfates with various strains of sulfate bacteria.

These bacteria, harmless to health, will react in stagnant water that has been depleted of oxygen, and can produce hydrogen sulfide gas. These bacteria cannot grow in the presence of atmospheric oxygen, which may account for there not being noticed in cold water lines, and their presence in water heaters and hot water lines.

Other types of bacteria, such as iron or manganese bacteria, utilize these elements for their cell wall production, and produce slime in wells and piping in addition to odors.

Iron and Manganese Odors

It is important to note that odors from iron and manganese (such as rusty odors, or oily odors) will not be eliminated by shock chlorination. Iron and manganese are usually found in a dissolved or clear state in well waters, and will color the water after exposure to oxygen or other oxidants such as chlorine. In some cases, shock chlorination of waters high in iron or manganese will turn clear water into rusty, orange, red, pink, or black water depending on the water chemistry and levels of iron or manganese present.

Note of Caution:

Shock chlorination of wells or piping systems may loosen up scale, iron deposits and other materials, which can clog fixtures, appliances and valves in the piping system. Care should be taken when flushing the piping, and all aerators removed to prevent clogging. In some extreme cases of corroded piping, the piping may fail and start to leak after this procedure. Chlorination will not remove nitrate or other contaminants.

28.1 Shock Chlorination Using Chlorine Bleach:

1. Clean the well house, springhouse or storage tank or reservoir. Remove debris and scrub or hose off any dirt or other deposits or interior surfaces. Pump to remove any suspended solids or foreign matter in the water if possible. Scrub interior surfaces with a strong chlorine solution containing ½ gallon household bleach, or ¼ gallon of pool chlorine to each 5 gallons of water.
2. Determine how much chlorine to use to disinfect your well by consulting Table 1. If you don't know your well depth, contact your well driller as they often keep records that will show the depth of the well. Table 1 Wells: Amount of 5.25% bleach (sodium hypochlorite) needed for disinfection to obtain approximately a 50 PPM chlorine solution in the well. If using pool chlorine (12% sodium hypochlorite) double amounts below.

Well Casing Diameter	Distance From Water Level to Bottom of Well (Water Depth)					
	0' - 50'	50' - 100'	100' - 200'	200' - 300'	300' - 400'	400' - 500'
4"	8 oz.	½ qt.	1 qt.	2 qt.	¾ gal.	¾ gal.
6"	½ qt.	1 qt.	¾ gal.	1 gal.	1 ¼ gal.	1 ½ gal.
8" - 12"	½ gal.	¾ gal.	1 ¼ gal.	1 ¾ gal.	2 ½ gal.	3 gal.
12" - 16"	½ gal.	1 gal.	2 gal.	3 gal.	4 gal.	5 gal.
20" - 24"	1 gal.	3 gal.	5 gal.	7 gal.	9 gal.	11 gal.
30" - 36"	3 gal.	5 gal.	10 gal.	15 gal.	20 gal.	25 gal.

Newer model
remove 6 bolts
and lift off cap

Older model
loosen set
screws, lift off

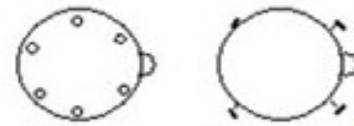

Well cap style 2. Top of well where pipe enters side of well.

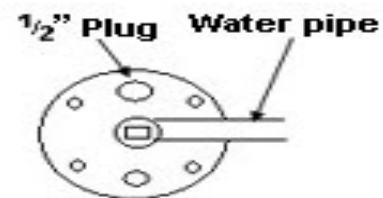

Some wells have four bolts, one ½" plug, and one hole for pump wire. In this type, pump pipe or drop pipe typically comes out the top of the well cap or seal. Do not remove top bolts for access without consulting a well driller or pump installer.

EXAMPLE: The well is 4" in diameter, with a depth of 400 feet. The water level is 100 feet below the surface. $400 - 100 = 300$ feet. From Table 1, a 4 inch well with 300 feet of water takes 1 quart of bleach. NOTE: In applications where it is inconvenient to determine water depth, at least $\frac{1}{2}$ gallon of household bleach, or $\frac{1}{4}$ gallon of pool chlorine, may be used for wells up to 8" in diameter with water estimated to be less than 80 feet deep; one gallon should be used for similar sized wells with water greater than 80 feet.

3. Mix the chlorine solution above with 10 times as much water before pouring down well. Avoid pouring strong bleach down the well.
4. Open the well cap, or if your well has a well top seal, remove the $\frac{1}{2}$ " plug or air vent and use a large funnel to pour chlorine down well. CAUTION: well caps and seals are integral to the safety and integrity of your well. They are often regulated by state and local codes. Be certain to comply with all applicable codes and licensing laws whenever opening a well. If you are unsure of any of the following steps, seek the assistance of a qualified or licensed well driller, pump installer, or contractor.
5. Do not attempt to remove the sanitary well seal without the assistance of a qualified well driller or pump contractor. Do not loosen the bolts that compress the seal.
6. Wells equipped with a packer jet pump can be thoroughly disinfected only through the removal of the pipe, pump and jet unit from the well.
7. As you are adding the chlorine solution, take precautions to protect yourself from splashing chlorine and fumes. Protect your eyes with safety goggles, and wear protective gloves and clothing.
8. Pour the chlorine solution down the well. Avoid pouring the chlorine solution on the pump wire connectors. If in doubt, use dry chlorine pellets (see Method II).
9. If the well is relatively deep, the disinfectant may be dispersed to the bottom by alternatively starting and stopping the pump several times. If possible, place a garden hose in the top of the well, and turn on the faucet and circulate the chlorine solution for 15 minutes until a strong 50 PPM chlorine residual is detected with a chlorine test kit.
10. Add more bleach as needed to bring up the chlorine solution residual in the well to 50 to 100 PPM.
11. If possible, circulate the water from the well by connecting a garden hose to a nearby hose bib or sill cock, and feed the water back down into the well. This will also wash down the sides of the well and insure proper mixing. After approximately 15 minutes a strong chlorine odor should develop. For more precise results, use a chlorine test kit to make sure the chlorine is over 50 PPM.
12. Water should be pumped from the well into the pressure tank and plumbing system.
13. All water faucets should be turned on in the house and all outside fixtures and hose bibs including fire hydrants, watering troughs, and other supply lines to other buildings, until 50 PPM is detected.

14. At this point, turn off the fixtures and let remain in the pipes a minimum of 2 hours, up to 12 hours or overnight.

15. After the chlorine has been left in the well and the plumbing system if applicable for a minimum of two hours, the chlorinated water can be discharged. Large amounts of chlorinated water should not be discharged into the septic tank, or onto lawns or gardens.

If possible, discharge as much of the water as possible through an outside faucet with hose attachment. Do not discharge the chlorinated water into streams or rivers. The small amount of chlorinated water, which remains in the household plumbing, can be discharge into the septic system.

16. Backwash water softeners, flush the water heater, and replace all filters if present.

17. For wells and piping systems that have bacterial contamination or have been flooded, resample the water and retest for coliform, after all the chlorine residual is gone.

18. If bacteria are detected again, repeat procedures above. Until a safe test result is obtained, use an alternate known safe water source, or boil all water, or use bottled water. In case of large diameter wells, a greater quantity of chlorine solution is needed. As a general rule, it takes 1 gallon of 5% bleach to treat 1000 gallons of water with 50 PPM of chlorine.

NOTE OF CAUTION: Heavily fouled wells can sometimes clog pipes and cause damage to pumps during or after shock chlorination. While this is rare, consult a well contractor or pump company if you notice any loss of pressure or water flow after chlorinating a heavily-fouled well. For heavily iron-fouled wells, severe contamination with bio-films or slime, or excessive levels of hydrogen sulfide gas, apply a 100 PPM or 200 PPM residual.

Wells with submersible pumps have pipes that enter either through the top or through the side. Many wells are under ground or in vaults in areas with freezing temperatures:

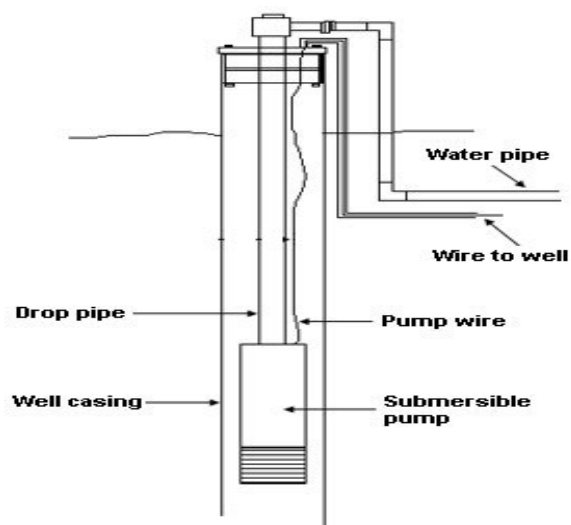

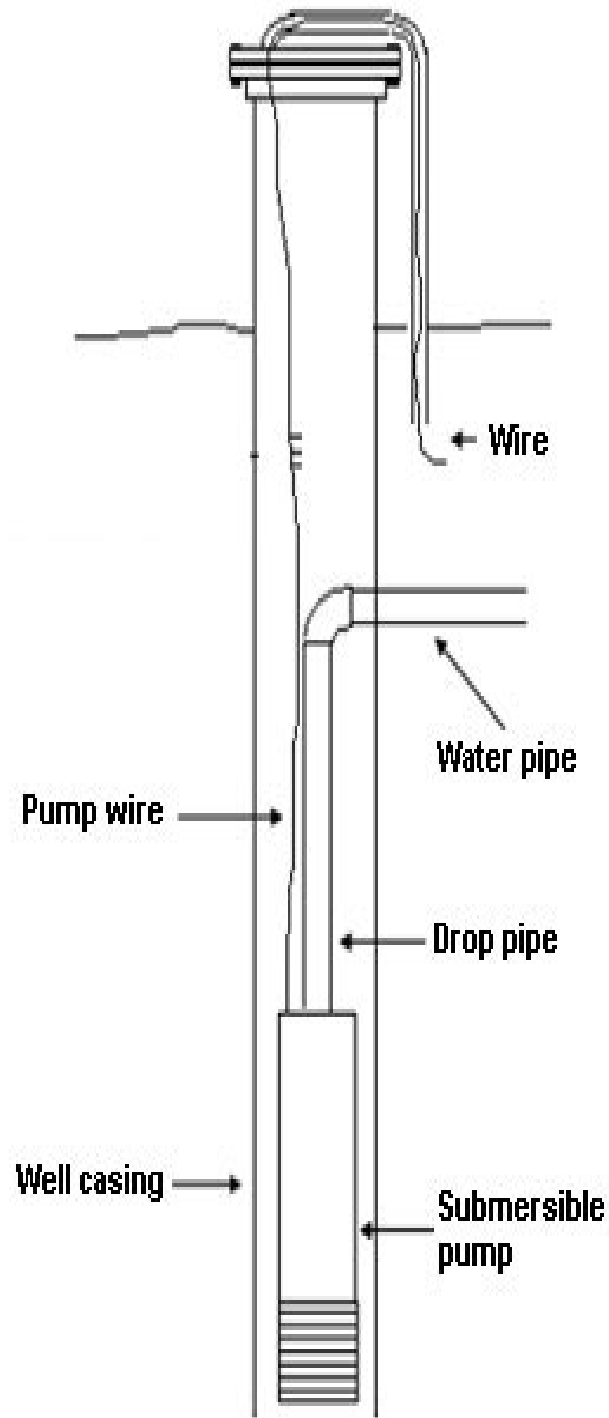

29. How to Sanitize Pipes & Plumbing

New plumbing in residential and commercial buildings, pipelines and distribution systems should be sanitized to kill bacteria when first put on line, or if repairs or service have been performed. Shock chlorination is one of the most popular methods for sanitizing pipelines. Chlorine's powerful germicidal action eliminates slime, bacteria, molds, and algae.

The threat of excessive microbial growth along the interior walls of drinking water distribution pipes is a major health concern of water distribution officials. Bio-fouling -- the development of an organic bacterial community, also commonly known as bio-film -- is caused by microorganisms and their secretions. It is present in almost every water distribution system, and when uncontrolled may present a threat to public health.

Bio-films are layers of bacteria that attach to the interior walls of water distribution pipes and to one another -- most heavily around corroded surfaces on pipes.

The bacterial community traps nutrients, microbes, and waterborne pathogens to eventually form an almost impenetrable material. Almost immediately after attaching itself to pipeline walls, the organism begins building upon itself, adding layer upon layer, forming a plaque-like coating.



The start of bio-film growth can begin when the pipeline or distribution system is new due to the presence of dirt, foreign material, piping construction materials and bacteria from workers and the environment introduced during the construction phase. Additional contamination can occur if the piping is serviced or repaired.

It is extremely important that when a new pipeline or plumbing system is put in service or repaired, a thorough sanitizing and cleaning of the piping is done.

Advantages of sanitizing with shock-chlorination include:

- Inactivates disease bacteria
- Cleans piping and equipment of dirt and debris
- Helps to prevent against bio-film formation

Proper and effective shock-chlorination procedure requires:

1. A dosage of 50 to 200 PPM of free chlorine evenly distributed throughout the piping and fixtures
2. Test of residual to verify that the levels are present at the fixtures and hose bib or valve sections
3. Contact time with the piping, undisturbed for 12 hours
4. Retesting of chlorine residual after 12 hours
5. If the chlorine residual is less than 10 PPM after 12 hours, repeat the entire procedure above. If the beginning dose is 50 to 100 PPM and the remaining residual after 12 hours is less than 10 PPM, this indicates severe bio-fouling or large amounts of dirt or slime present.

29.1 Shock-chlorination using the “Slug-in Method”:

Generally, we don't recommend this method, since it relies on introducing a “slug” (a large amount of chlorine, usually powdered bleach or tablets) into one section of the pipeline, and hoping that this concentrated dose will properly sanitize the downstream sections. This is unreliable, and does not introduce a consistent, evenly distributed chlorine residual of 50 to 200 PPM throughout the system. It allows diluted water with varying residual levels of chlorine to flush through the system. It also can create very high levels of corrosive chlorine (over 500 PPM) which can damage fixtures and corrode copper and stainless steel.

29.2 Shock Chlorination Procedure by High-Pressure Metering Pump Injection:

Professional water treatment specialists and distribution system operators typically use this method. The procedure involves leaving the water system or pipeline under pressure and using a high pressure, low-volume metering pump to inject a concentrated chlorine solution while the water is flowing at a given flow rate. After a chlorine residual of 50 to 100 PPM is detected at each faucet or fixture (using a high-range chlorine test kit) the chlorine solution can remain in the pipes for 12 to 24 hours.

2. Shut off the main line. Identify an outside hose bib or other opening in the incoming piping, on the customer side of the main valve. If a back-flow prevention valve is present, these can be utilized, as there is typically a ¼” FPT port available. If no hose bib or opening exists, install a ¼” or ½” threaded opening into the main line to use for injecting the chlorine solution.
3. Hook up a metering pump to the line (in our example, a 24 gallon/day output metering pump is used) using an injection check valve so the water cannot back-feed into the metering pump. If the metering pump has a different output, adjust speed of pump or solution strength.

4. In this procedure, a concentrated chlorine residual will be injected while the pipes are under line pressure from the street or city-water system, so a check valve is used on the tubing leading to the piping to prevent the water from backing up into the metering pump.
3. Make sure to use a metering pump that can develop pressures higher than the pipeline pressure.
4. Determine flow rate. Open both hot and cold faucets and read the water meter to determine gallons per minute.
5. Use the formula and example below to adjust the metering pump: **Example:** Compute metering pump setting to achieve 100 PPM applied chlorine dosage in a water stream flowing at 5 gallons per minute, using 5% bleach: $5 \text{ GPM} \times 100 \text{ PPM} \times 1440 \text{ (minutes/day)} = 13.7 \text{ gallons per day}$ 52,500 (PPM). Output of pump is 24 gallons per day. The example above calls for 13.7 gallons a day output. $13.7/24 \text{ gallons per day} = .57$ or 57%. Therefore, set metering pump speed to 57%.
6. Run the water in the building or at a valve or hose bib downstream until the bleach solution has filled all the pipes and a strong odor of chlorine is coming from the fixtures or faucets, both hot and cold. For best results, test the water at each fixture to verify that there is at least a 50 to 100 PPM chlorine residual, using a DPD method test kit.
7. Allow the water to sit for 12 hours. Retest for chlorine residual. The slime, scale, and odor-producing bacteria will interact with the chlorine and reduce the amount of chlorine residual in the piping. If the water contains less than 10 PPM of chlorine, repeat entire procedure.
8. Flush the piping and fixtures well to flush out scale and colored water from the piping. Unscrew aerators and fixtures to avoid these items becoming plugged with sediment that may have been loosened in the chlorination process.

Caution: If the shock-chlorination procedure is being done on an old pipeline, or one that has accumulated scale or buildup, the procedure can loosen up scale, iron deposits and other materials in the piping, which can clog fixtures, appliances and valves in the piping system, causing a lot of problems. Care should be taken when flushing the piping, and all aerators removed to prevent clogging. In some extreme cases of corroded piping, the piping could fail and start to leak after this procedure.

30. Well Troubleshooting Guide

There are four common symptoms that are associated with most water well problems:

1. Reduced well yields
2. Sediment of other contaminants
3. Changes in water quality
4. Dissolved gasses or bubbles in the water

Note that in many cases the well problem can be the result of a combination of causes and so correcting the problem may require more than one action.

30.1 Top 5 Warning Signs Your Water Well Is In Trouble

1. The well is pumping air
2. The well is pumping sand
3. The power bill has skyrocketed
4. Low water pressure
5. The pressure switch and pump continuously cycles on and off

Your water well is an amazing resource and can produce many years of great water with little or no maintenance. Precisely because most wells perform for many years with no maintenance, many homeowners may not realize that their well needs service or maintenance until it is too late.

Fortunately, there are some tell-tale signs you can look for that can alert you to well water problems.

How A Typical Well Pump System Works

Typical residential water wells usually have a submersible that is submerged under the water and pumps water directly to the house. Some wells have pumps called "jet pumps" that are located on the surface or top of the well. Most well pumps are used in conjunction with a pressure tank.

The goal of the well water pump system is to maintain a constant supply of pressurized water in the house and piping system. In order to maintain the water pressure the well pump is switched on and off with a pressure switch.

This usually means the pump is turned on when the pressure switch senses the pressure is at a low point (the "cut-in" point) and off at a pre-set high pressure point (the "cut-off" point).

In some systems there is no simple on and off pressure switch but rather a pressure sensor that works with a controller to allow the pump to pump more or less in a gradual method, which is called a "constant pressure" system.

This uses a variable speed pump, which allows the pump motor to spin faster or slower, and pump water faster or slower based on the pressure sensor. These are becoming increasingly popular but the most common is the simple off and on pump system uses a simple pressure switch.

The Well Is Pumping Air

If you turn on your water tap and out blasts a mixture of air and water, this a serious warning sign that something is wrong in the well. The worst-case scenario is that your water table has dropped to a point that is at or below the well pump, and the pump is sucking in air at some point during the pump cycle.

Another cause is that the well pump drop pipe (the pipe that connects the pump to the top of the well and the water system) is broken. Drop pipes are made of either iron pipe or plastic PVC or poly pipe. The can become broken or corroded and develop holes or in some cases break apart, allowing air to be sucked in. Is the air dissolved in the water, or is it spurting out of the tap in big bursts? This type of problem needs to be investigated and repaired by a professional well or pump contractor.

In some cases, the water level is fine and there are no broken pipes or fittings. Some ground water tables do contain various types of gasses. These gasses may be dissolved in the water, but later come out of solution and cause water to spurt or sputter at the top. These gasses might be carbon dioxide, methane, hydrogen sulfide or other gasses, and can be dangerous and cause serious health and safety problems. If this is an on-going problem the well can be treated to remove these gasses through aeration and degassing systems.

The Well Is Pumping Sand

If your well suddenly starts to pump sand, this is often a sign that the well is silting in, or filling with sand and silt. Typically, the well pump is installed so it is at least 10 - 20 feet above the bottom of the well. When the pump turns on the water level in the well can drop to a lower level. If the pump is down near the bottom of the well, sand and sediment can be sucked in.

Other causes for sand in water can be that the well screen has become degraded and is allowing sand or sediment in from the gravel pack around the well screen. Sand is very hard on the well pump and can quickly wear out the pump, valves and fill up the bottom of the well.

In any case, a sudden presence of sand is not a good sign and the cause should be determined.

Sand can be removed from the water before the pressure tank or storage tank by means of a centrifugal sand separator or a 60 mesh filter screen with automatic purge valve.

The Electricity Bill Is Suddenly Very High

When a pump wears out, becomes clogged with sand, silt or iron bacteria it has to work much harder than if it was in good shape. This can lead to an increasingly higher power bill. Another common cause of a high power bill is when the check valve in the well goes bad.

This allows water from the pressure tank to stream back down into the well, which in turn lowers the pressure and signals to the pressure switch to turn the pump on again and re-pressurize the pressure tank. This on and off cycle may occur every few minutes and essentially allow the well pump to run practically 24 hours a day, causing a high power bill.

Low Water Pressure

There can be many causes of low water pressure including a failing well pump, stuck check valve, partially closed or bad gate or ball valve, and leaking or failing pressure tank. In some cases iron bacteria clogs up the pipe nipple leading to the pressure switch which causes the pressure switch to incorrectly sense the pressure.

If your well water tests high in iron bacteria, your pump and/or well screen may becoming clogged with iron bacteria. Having the well cleaned with a special solution designed to remove iron bacteria, slime and scale can often restore the well to a better condition.

In some well systems the pressure is often set to turn on at 30 PSI and off at 50 PSI. For today's homes and appliances this pressure can be too low. Often it is possible to raise the pressure so the pump turns on at 40 to 50 PSI and off at 60 to 70 PSI providing more adequate water pressure in the home.

The pressure switch can often be adjusted to accommodate this higher pressure, assuming the well pump and well can operate without difficulty at the higher pressure. Air pressure inside the pressure tank must be adjusted if the pressure switch is adjusted.

Pressure Switch and Pump Continuously Cycles On and Off

This can be caused by a leak in the home so the well pump is continuously running. Look for leaking toilet flush valves, reverse osmosis systems, iron filters and other backwashing filter systems that may be malfunctioning.

The most common cause though is a failed check valve. The check valve or foot valve prevents the well pressure tank from sending water back down into the well after it has built up with water pressure. If the valve fails water streams back down the well and the pressure switch turns the pump on again. Replace the check valve and the problem is solved.

30.2 Causes of Sediment, Rust, Minerals or Odors

Possible causes:	What to check for:	How to correct:
Natural water quality conditions such as iron, manganese, sand, sediment, tannins, low pH, high pH, high total dissolved solids, bacteria or other problems	Have water analyzed for general mineral, physical, and bacterial parameters.	Based on water quality parameters, install water treatment system.
Improper well design or construction	Sediment appears in water shortly after well completion. Remove pump and use down-hole video camera to inspect well casing and screen.	Contact a licensed drilling contractor to repair the construction problem.
Insufficient well development after construction	Sediment appears shortly after well completion. Well production may improve with pumping. If not, install sediment backwash filter or whole house filter cartridge.	Have a licensed drilling contractor redevelop the well or install water treatment system.
Continuous over pumping of well	Sediment appears in water shortly after well completion	Compare current discharge rate of well with the driller's recommended rate. If the current flow rate is higher, install a flow restrictor on pump. If required, install cistern to meet peak water requirements.
Corrosion of well casing, liner or screen causing holes	Sudden appearance of sediment in water when there was no previous problem. Often coupled with a change in water quality. Get a complete water analysis to determine problem.	Consult a licensed drilling contractor. Depending on the well construction, repair or replace well. Alternate construction materials may be required.
Failure of the annulus or casing seal	Sudden appearance of sediment, coupled with a change in water quality	Consult a licensed drilling contractor. It may be possible to re-establish the seal. Test water quality regularly and investigate when quality changes occur.

Possible causes:	What to check for:	How to correct:
------------------	--------------------	-----------------

Corrosion of well casing, liner or screen, causing holes. Holes can allow water of undesirable quality to enter the well.	Change in water quality, often coupled with sudden appearance of sediment in water. Calculate the Ryznar Stability Index to determine the water's corrosion potential.	Consult with a licensed drilling contractor about possible repair. Alternate construction materials may be required.
Failure of the annulus or casing seal	Change in water quality and possible appearance of sediment.	Consult with a licensed drilling contractor about possible repair.
Iron bacteria or sulfate-reducing bacteria (biofouling)	Change in water quality such as color, odor (e.g. rotten egg) or taste. Check inside of toilet tank for slime buildup and inspect pump.	Shock chlorinate well water and piping system
Contamination from man-made sources	Changes in water quality as indicated by color, odor or taste. Compare results from regular water analyses for changes.	Identify and remove contamination source. Have water analyzed through local health unit to ensure it is safe to drink.
Limited aquifer extent/Reduced aquifer recharge	Increase in constituents such as hardness, iron, manganese and sulfate. Compare results from original water analyses for changes. Taste and colour changes in the water may also occur.	For surface aquifers, trapping or impounding surface water can enhance aquifer recharge and improve water quality.

30.3 Dissolved Gasses or Air in Water

Possible causes:	What to check for:	How to correct:
Dissolved gases in well water including carbon dioxide and methane	Spurting household water taps/Milky color to the water which lasts only a few seconds	Install a storage tank with air vent, or in some cases, install an air vent tank. Make sure tank is vented properly outside.
Malfunctioning pump or over-pumping the well	Compare the rate at which you are pumping the well with the rate recommended by the driller. Check for leaks in well drop pipe. Check for failed check or foot valve that allows water to drain back down well. In some cases, the well may be drawing down so much that it sucks air, meaning the well is going dry. Refer to owners guide for your particular pumping system.	Have a licensed drilling contractor/pump specialist or plumber check the pump and pressure system equipment for malfunction. Make sure that any new pumping equipment is sized correctly to meet the production capability of the well. Reduce well pumping rate if necessary and install cistern to meet peak water requirements.

30.4 How Your Well Works

Your private water system has two important components in addition to the well itself – a pump and a pressure tank.

Pumps: There are many types and sizes of pumps for water systems. Some are only designed to remove water from a source. Others not only remove the water, but also force it through the rest of the water system.

Some pumps are for special jobs such as boosting pressure or supplying a special outlet. If your pumping installation is not properly planned, you will not receive satisfactory water service.

Pressure tanks: Pressure tanks provide storage for your water system. There are three general types of water storage tanks:

- Diaphragm bladder tanks with permanent separation between the air and water;
- Tanks with a float or water separating the air from the water (not used in recent years)
- Plain steel tanks - each kind of tank serves a specific purpose.

Additional storage: Some well owners like to make arrangements for additional water storage tanks. Additional storage capacity of one day's water supply is sufficient. Additional water storage is useful when there are power outages and other emergencies.

For information on your well:

Contact the well contractor who installed your well. Or find a water well contractor in your area by looking in your local telephone directory. Many states maintain lists of licensed or registered well drillers.

Contact your local health department to find out where in your state you can locate a list. Most states also have state water well associations, state well driller associations or state ground water associations. To get a list of these associations, you can contact the National Ground Water Association at 800-551-7379 or www.ngwa.org.

Typical Well Water System Components

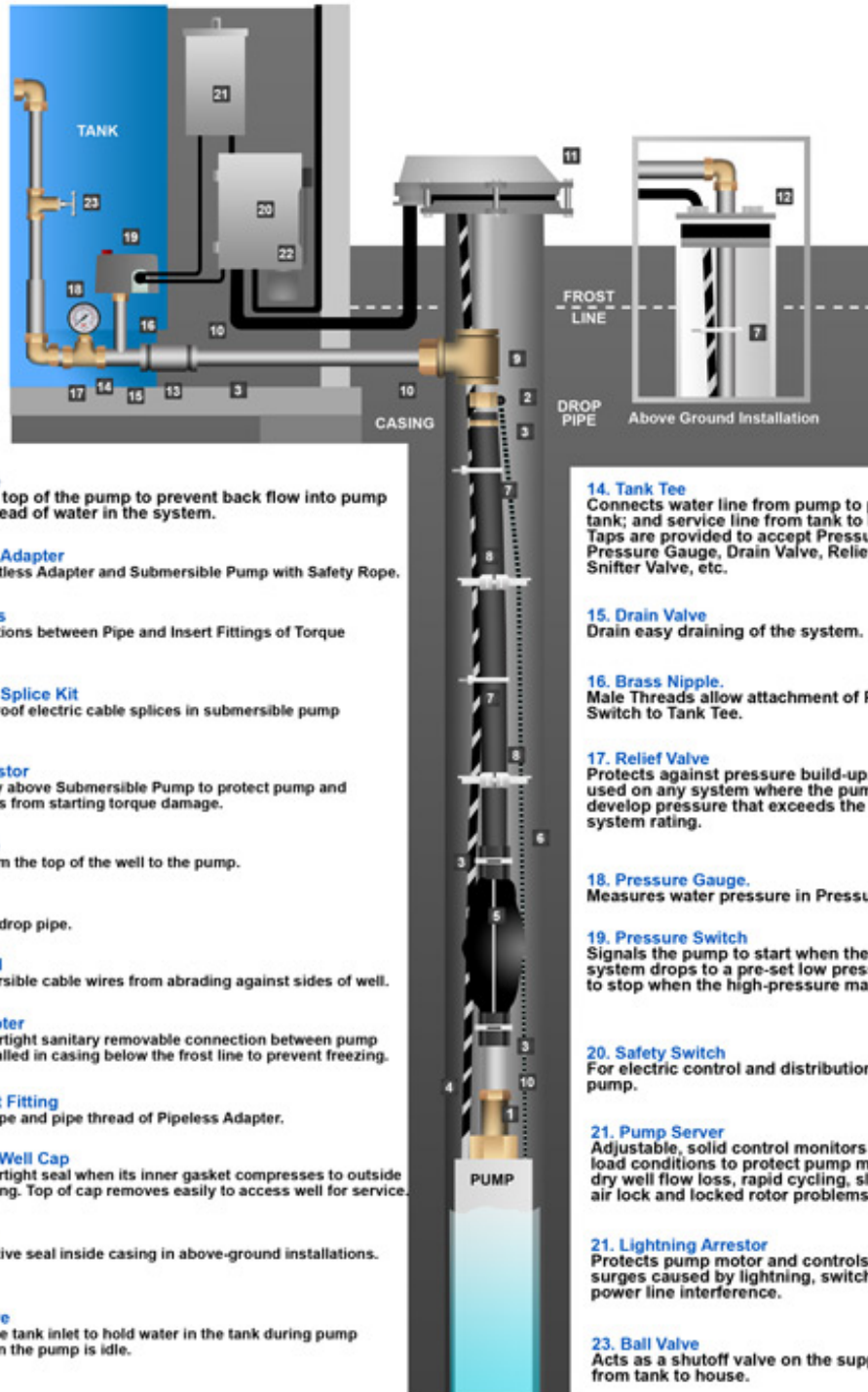

1. Check Valve

Located at the top of the pump to prevent back flow into pump and hold the head of water in the system.

2. Brass Rope Adapter

Connects the Pitless Adapter and Submersible Pump with Safety Rope.

3. Ideal Clamps

Provide connections between Pipe and Insert Fittings of Torque Arrestor.

4. Heat Shrink Splice Kit

Enables waterproof electric cable splices in submersible pump installations.

5. Torque Arrestor

Installed directly above Submersible Pump to protect pump and well components from starting torque damage.

6. Safety Rope

A safety line from the top of the well to the pump.

7. Cable Tie

Fasten cable to drop pipe.

8. Cable Guard

Protects submersible cable wires from abrading against sides of well.

9. Pitless Adapter

Provides a watertight sanitary removable connection between pump and house. Installed in casing below the frost line to prevent freezing.

10. Brass Insert Fitting

Connects poly pipe and pipe thread of Pitless Adapter.

11. Watertight Well Cap

Provides a watertight seal when its inner gasket compresses to outside diameter of casing. Top of cap removes easily to access well for service.

12. Well Seal

Provides a positive seal inside casing in above-ground installations.

13. Check Valve

Installed near the tank inlet to hold water in the tank during pump installation when the pump is idle.

14. Tank Tee

Connects water line from pump to pressure tank; and service line from tank to house. Taps are provided to accept Pressure Switch, Pressure Gauge, Drain Valve, Relief Valve, Snifter Valve, etc.

15. Drain Valve

Drain easy draining of the system.

16. Brass Nipple

Male Threads allow attachment of Pressure Switch to Tank Tee.

17. Relief Valve

Protects against pressure build-up. Should be used on any system where the pump could develop pressure that exceeds the maximum system rating.

18. Pressure Gauge

Measures water pressure in Pressure Tank.

19. Pressure Switch

Signals the pump to start when the water system drops to a pre-set low pressure, and to stop when the high-pressure mark is reached

20. Safety Switch

For electric control and distribution to the pump.

21. Pump Server

Adjustable, solid control monitors system load conditions to protect pump motor from dry well flow loss, rapid cycling, slow recovery, air lock and locked rotor problems.

21. Lightning Arrestor

Protects pump motor and controls from voltage surges caused by lightning, switching loads and power line interference.

23. Ball Valve

Acts as a shutoff valve on the supply line from tank to house.

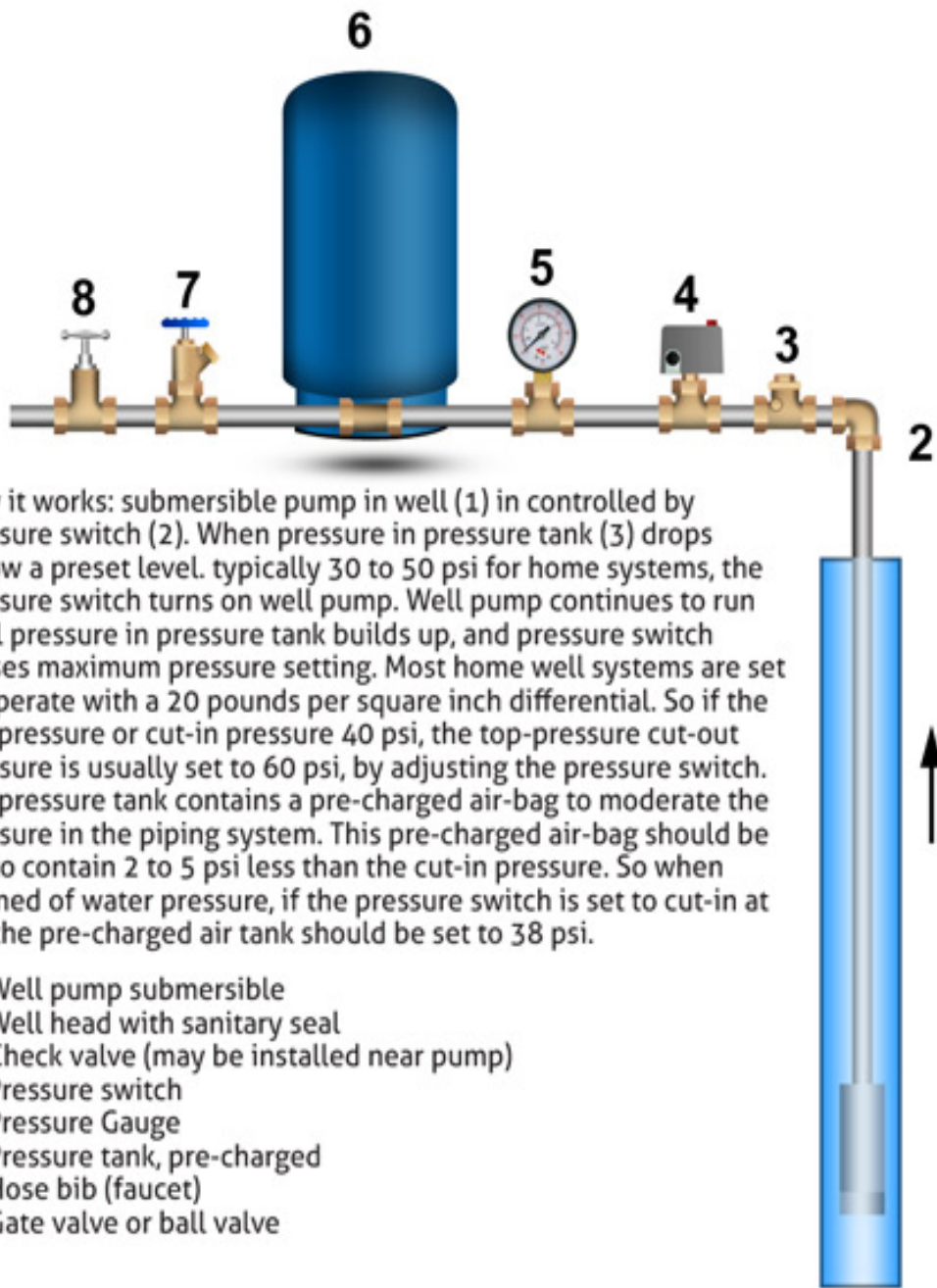

How it works: submersible pump in well (1) is controlled by pressure switch (2). When pressure in pressure tank (3) drops below a preset level, typically 30 to 50 psi for home systems, the pressure switch turns on well pump. Well pump continues to run until pressure in pressure tank builds up, and pressure switch senses maximum pressure setting. Most home well systems are set to operate with a 20 pounds per square inch differential. So if the low pressure or cut-in pressure 40 psi, the top-pressure cut-out pressure is usually set to 60 psi, by adjusting the pressure switch. The pressure tank contains a pre-charged air-bag to moderate the pressure in the piping system. This pre-charged air-bag should be set to contain 2 to 5 psi less than the cut-in pressure. So when drained of water pressure, if the pressure switch is set to cut-in at 40, the pre-charged air tank should be set to 38 psi.

- 1 - Well pump submersible
- 2 - Well head with sanitary seal
- 3 - Check valve (may be installed near pump)
- 4 - Pressure switch
- 5 - Pressure Gauge
- 6 - Pressure tank, pre-charged
- 7 - Hose bib (faucet)
- 8 - Gate valve or ball valve

Some wells use above ground storage tanks, which can be a big advantage not only in increased water storage, but in various water treatment processes. For instance, a storage tank will allow gasses and in some cases odors to vent off, and sediment to settle out before being pumped to home.

Some wells use under-ground storage tanks called cisterns:

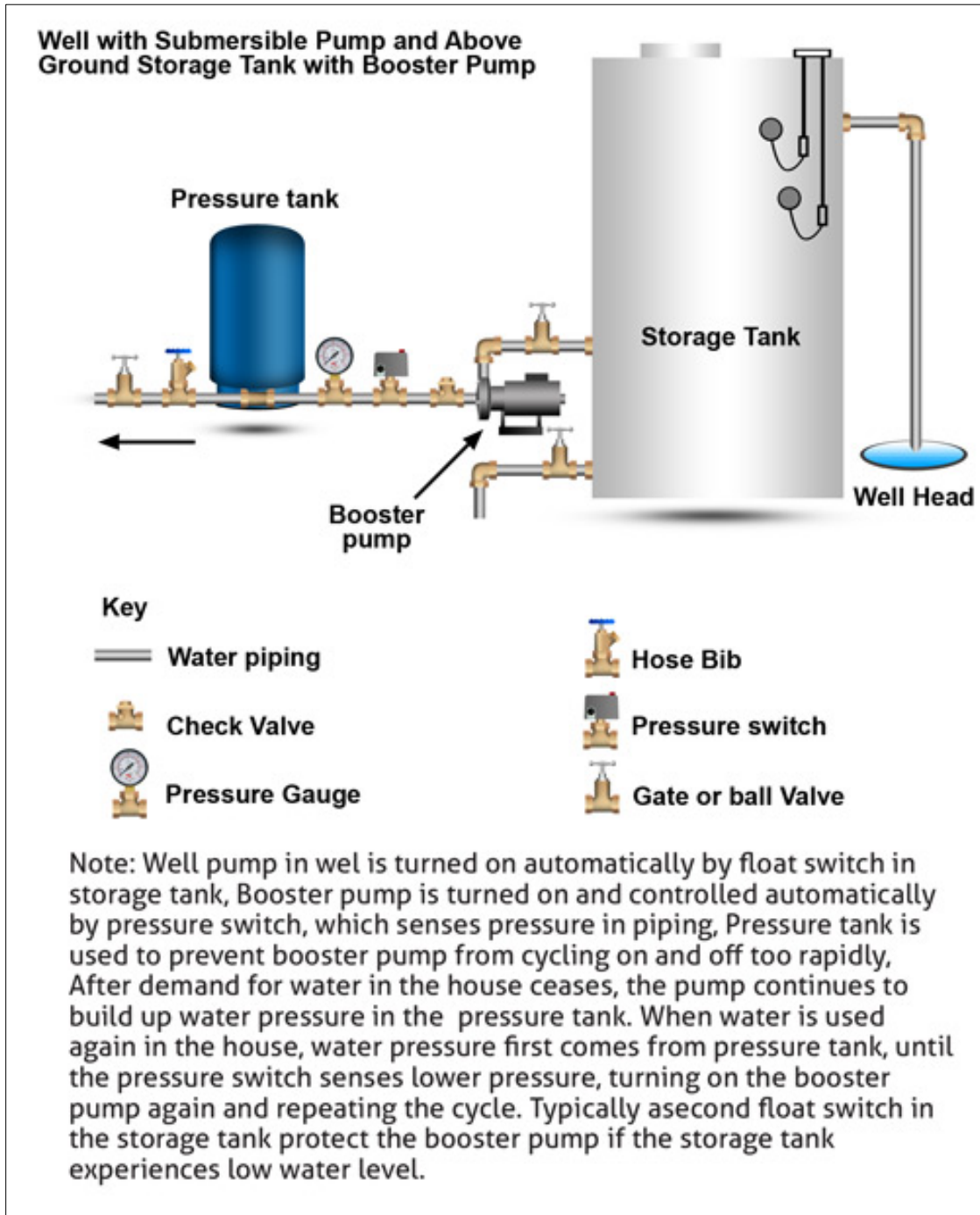

31. Case Studies

Here are a few selected case studies and emails from our customers.

31.1 After Neutralizer and Pro-OX Iron Filter: Crystal Clear and Tastes Like Spring Water.

We received this email from Mr. Roger Coulombe in Colbert Georgia. Mr. Coulombe had purchased and installed his CWS 5900e Neutralizer Filter (almond colored tank in his picture) and [Pro-OX 5900e Iron Filter](#) (black tank). His well water had low pH (acid water), and iron. Great job Mr Coulombe, installation looks really good!

Here are his comments:

We were delayed installing the Neutralizer and Filter System. We bought this property in GA in November and it was necessary to completely rewire the pump house, not because your system needed it, but it was a dangerous bit of wiring.

After putting down a cement pad, installing a new holding tank we proceeded to install the Neutralizer and Filter System. It was a lot of work, but easy to figure out, your instructions were easy to follow. Now that it's been programmed and in for a week I just can't believe the quality of the water.

It is crystal clear, the PH is at a perfect 7 and it tastes like spring water. Laundry and dishes come clean quicker, and showering is a whole new world for our skin. We can now put the counter top drinking water filter away and hook up our refrigerator ice maker and water dispenser. Thank you for having such a great system with little future maintenance. Roger Coulombe, Colbert, GA <http://support.cleanwaterstore.com/blog/neutralizer-pro-ox-iron-filter-crystal-clear-tastes-like-spring-water/>



31.2 Upgrading a System with the Greensand Iron Filter

Scott needed a solution for iron and manganese problems, along with removing residual chlorine in his water after chlorine and soda ash injection for acidic water. We offered him a Greensand Iron Filter CWS Plus, a very effective filter that can take out high levels of both iron and manganese with one media. The filter uses a Greensand media that oxidizes and removes iron and manganese molecules, along with sulfur odors as well!

The Greensand media has to be chemically regenerated by potassium permanganate in order to oxidize and refresh the media to optimal capacity. Scott has a two-pump system: one chlorine injection for treating sulfur odors, and another a soda ash injector that raises his acidic pH to more neutral levels.

At the end of the filter system, Scott installed a Carbon Filter 5700e to remove residual chemicals in the water after treatment, like chlorine. The carbon coconut shell media in the Carbon Filter 5700e filters out chlorine and sediment, then the electronic control valve automatically backwashes out the contaminant.

This finalizes Scott's water treatment, leaving behind pure, crystal clear water.

See below what Scott had to say about his upgraded system, with pictures of his before and after:

“I was able to complete this project in 1 day. Instructions were easy to follow and although I’m not a fan of plumbing this was fun. Our water went from spotty at best (no pun intended) with iron, manganese, and chlorine to absolutely perfect. No iron, no manganese, and a PH (with chlorine and soda ash injection) of 8.0. I posted on Facebook to let my neighbors know about you since there are so many homes that have the same problem but not the right solution. Here are my before and after photos as requested.”

Before receiving the Clean Water Systems makeover



After,



31.3 Pro-Ox Iron Filter: “This new system is great! It was easy”

” Hi, here are pictures of my new Pro-Ox 7000 SXT iron filter system:



Compared to the old potassium permanganate system with its bucket full of black “ink” and its myriad of pipes running everywhere – not to mention it’s 2 hour recharge every 4 or 5 days – this new system is great! It was easy – and fun – to install.

I checked the iron ppm both before and after the iron filter using an electronic tester and it reduced from 3.9 ppm to 0.14 ppm.

It only needs to backwash/rinse every 1000 gallons and does this based on water consumption. In my case since I live alone it’s about every 2 weeks! Also the backwash and rinse cycles are only about minutes each! Fully recommend.” - Art Wild, Washington, Illinois

31.4 Pro-OX AIR Cures Rusty, Murky Water

Nancy and her family were suffering for over ten years drinking bad tasting, rust-colored and staining water. They installed a previous iron filtering system but it couldn't keep up with the amount of iron they had in their well.

That's why we recommended her the [Pro-OX AIR iron filter](#), the most robust system we sell for eliminating iron from well water. Using a combination of aeration and Pro-OX media, the Pro-OX AIR iron filter can remove up to 10 ppm of iron from the water. The Pro-OX AIR maintains an air pocket at the top of the tank which it utilizes to aerate the water and oxidize the iron molecules, giving the Pro-OX media an easier time removing the iron.

See below what Nancy had to say about her new water:

"I have been leery about sending this email because our water is so FANTASTIC, I am afraid I might jinx it by saying anything !!! It took us about 9 hours to install but that was because our incoming and outgoing lines were opposite on the head. My husband rerouted the pipes and it hooked up like a charm. We have had great water from the moment after it ran its first cycle. This water is better than ANYTIME before and we have been in our new house for 16+ years. I only wish we would have used 'your system sooner. The filter we had been using (which we had installed new about 5 years ago) didn't come close to the clear water we have now. We have all said "it's almost a shock to lift the toilet lid and see clear water." Even when it wasn't very rusty, our water was always kind of cloudy or murky. We love to drink it too, I swear it even feels smooth! Our whole neighborhood has their own wells (we live in a rural area) and everyone has rusty water problems.

I have been telling everyone about your

company and how happy we are.

You have a forever customer with us !"

Nancy Newton. O'Fallon, MO

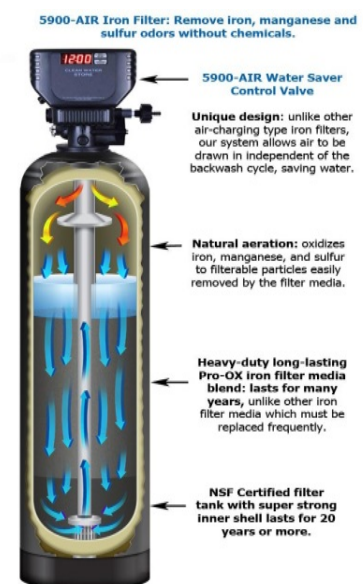

31.5 Pro-OX Iron Filter Tackling the Worst Iron Problems

Todd had an extreme iron problem in his home. His water test results for iron were coming out at over 7.0 ppm, nearly 20 times over the Environmental Protection Agency's (EPA's) limit for staining at 0.3 ppm. To treat such a big iron problem, we suggested the star of Clean Water Systems, the Pro-OX Iron Filter 5900e.

Pro-OX Iron Filters are the longest lasting and most powerful system for removing up to 15 ppm of iron, along with manganese, rust and sediment, from well water. This filter utilizes natural, high purity, NSF-certified manganese dioxide media that has a lifespan of 7-10 years, so Todd doesn't have to worry about maintenance anytime soon. The Pro-OX Iron Filter features a heavy duty automatic backwash control valve, the 5900e, which is fully adjustable for backwashing out the filtered contaminants and saves water to maximize performance.

Here's what Todd had to say about his new Pro-OX Iron Filter:

"The attached pics show my new Pro OX 5900e iron filter from Clean Water Systems. I have been using the iron filter for about 2 weeks now, and so far it's doing a great job of removing the iron. My iron has been running between 7.2 and 7.5 ppm from the well.

My testing of the water as it leaves the iron filter has been between 0.002 and 0.08 ppm. I do chlorination as the water enters the house and I have 2 – 75 gallon contact tanks just after my pressure tank (only 1 tank is pictured). So far I'm very happy with the performance of the Pro OX system. It seems to be doing a better job than my old system.

Overall I'm very satisfied with the performance of the filter, and it's saving me a ton of water. My old system had to wash every other day, and it used a ton of water and took close to 2 hours to do a cycle. I'm sure I'll make up some of the cost of this new iron filter in electricity and chlorine costs over time. I'd give my system 5 stars."



31.6 Bacteria Disinfection with the Wonder Light UV Sterilizer

Don was looking to improve his current [water filtration system](#) with some bacteria disinfection.

We recommended him the Wonder Light UV Sterilizer, which utilizes ultraviolet wavelengths to ‘deactivate’ bacteria and functionally kill them.

However, he then told us that his water was also hard, and discolored by some sort of brown particulate matter. Since the Wonder Light UV Sterilizer operates by light penetration, brown discoloration interferes and makes it less efficient at bacteria disinfection.



To also combat these extra issues, we recommended him a 5900e Water Softener 80K unit, along with tannin media, and a Big Blue 5 Micron Cartridge Filter. The tannin media removes tannins, which are organic molecules leached into the well water that cause brown discoloration (most commonly found in teas, that’s what gives the drink its distinct color!) by anion exchange.

The Big Blue 5 Micro Cartridge Filter was placed just before the Wonder Light UV Sterilizer to polish the water off and ensure clearness for proper bacteria disinfection. All these filters worked in harmonious conjunction to fully treat Don’s water and give him super clear, tasty water.

“Attached is a photo of our new well water system. It was easy to install and doesn’t reduce my water pressure. The system involves a calcite unit with a vortech tank then going into a 80k water softener to remove the small amount of iron and hardness added by the calcite. It then enters a second tank with 0.5 cuft of both cation and anion exchange to remove residual hardness and tannins.

We also added a 5 micron filter before entering the 15 gpm UV treatment just in case. The water is super clear and tastes [better than ever.](#)” - Don Taylor, Taylorsville, NC

31.7 Calcite Acid Neutralizer satisfaction.

Thomas installed a Calcite Acid Neutralizer for his house, and created this really creative outdoor set up! His low pH was making his water acidic, which was corroding his copper pipes and creating a flow of loose copper in his water. Since it was installed outdoors and susceptible to the elements, Thomas covered his neutralizer and pipes with cool landscape rock covers, protecting the system while also making it look appealing to the eye. Really nice setup Thomas!

“Real happy with the system! A few days after installation I was changing out a showerhead and a glob of copper scum disgorged itself proving the effectiveness of the calcite now being fed into the system.

Had the copper continued to erode I would have been akin to Big Bangs definition “like an inclined plane wrapped helically around an axis” (screwed) :) So needless to say I’m ecstatic ! It’s been a couple of months now and the copper staining has ceased and even an unknown film that gathered and floated in the dogs bowl of water is no longer there... Kudo’s Guys on your system !!! - Thomas, Walnut,



31.8 Sediment Backwash Filter Working as planned.

John and Melissa purchased a Sediment Backwash Well Water Filter, and a 25/1 micro dual grade filter cartridge in a Big Blue housing unit. Their house had major turbidity issues from their well water, that is, their water was full of sediment and inorganic contamination from the well.

At first they had just a 20 micron filter, which was letting through very fine material, like thinset mortar. After getting the Sediment Backwash Well Water Filter, its 5 micron capabilities effectively filtered out this particulate matter, leaving behind crystal clear water.

The 25/1 micron (25 outside, 1 inside) filter afterwards polishes off the water down to an amazing 1 micron of effectiveness, further increasing the purity of their water. No more dirty, turbid water for them! Here's what they had to say about their Clean Water System:

"Here are a few pictures of our sediment backwash filter for our well, along with the filter housing for a 25/1 filter. So far, the filters are working as planned! -- John and Melissa Anobile, Buffalo, WY



31.9 Multiple Filter System Water Is “Right on the Money”

Rick had a common mix of sulfur odor, brown staining and hard water issues, and needed a multiple filter system to resolve his problems in one simple set up. The system began with a [Precision-24 Chlorinator](#) that pumps a tiny amount of chlorine into his water to oxidize sulfur molecules, kill iron bacteria, and eliminate the odors in his water. The chlorine/water mixture sits in the grey contact tank to allow proper retention time for the chlorine to work.

Next, the water flows through his [5900e Automatic Carbon Backwash Filter](#) to remove sediment, rust, and any trace of chlorine and other odors and tastes. The final stage is his [5900e Salt Saver Water Softener](#). The water softener uses a high grade of ion exchange media to selectively remove molecules that make water hard like calcium and magnesium. The water softener is automatically regenerated by the automatic backwash 5900e control valve on demand only, saving thousands of gallons of water a year. The result is clean, odor-free, non-staining clean water throughout the [home](#).

Here’s what Rick had to say about his new water quality and equipment:

The equipment is fantastic and the water is “right on the money”. Your team was great to work with and I would highly recommend this system from The Clean Water Store to anyone wanting awesome well water. -- Sincerely, Rick Owens, Kingston, TN



32. Glossary of Terms



acid - A substance which releases hydrogen ions when dissolved in water. Most acids will dissolve the common metals, and will react with a base to form a neutral salt and water.

activated carbon - A granular material usually produced by the roasting of cellulose base substances, such as wood or coconut shells, in the absence of air. It has a very porous structure and is used in water conditioning as an adsorbent for organic matter and certain dissolved gases. It is sometimes called "activated charcoal".

adsorption - The process in which matter adheres to the surface of an adsorbent.

alkalinity - The quantitative capacity of a water or water solution to neutralize an acid. It is usually measured by titration with a standard acid solution of sulfuric acid, and expressed in terms of its calcium carbonate equivalent.

anion - A negatively charged ion in solution, such as bicarbonate, chloride or sulfate.

anion exchange - An ion exchange process in which anions in solution are exchanged for other anions from an ion exchanger. In demineralization, for example, bicarbonate, chloride and sulfate anions are removed from solution in exchange for a chemically equivalent number of hydroxide anions from the anion exchange resin.

aquifer - A layer or zone below the surface of the earth which is capable of yielding a significant volume of water.

attrition - The process in which solids are worn down or ground down by friction, often between particles of the same material. Filter media and ion exchange materials are subject to attrition during backwashing, regeneration and service.

backwash - The process in which beds of filter or ion exchange media are subjected to flow opposite to the service flow direction to loosen the bed and to flush suspended matter collected during the service run to waste.

bacteria - Unicellular micro-organisms which typically reproduce by cell division. Although usually classed as plants, bacteria contain no chlorophyll.

base - A substance which releases hydroxyl ions when dissolved in water. Bases react with acids to form a neutral salt and water.

bed - The exchange or filter media in a column or other tank or operational vessel.

bed depth - The height of the ion exchange or filter media in the vessel after preparation for service.

Birm - The brand name of a manganese oxide iron filter media sold by Clack Corp. Used to filter iron from water.

brine -A strong solution of salt(s), such as the sodium chloride brine used in the regeneration of ion exchange water softeners, but also applied to the mixed sodium, calcium and magnesium chloride waste solution from regeneration.

calcium - One of the principal elements making up the earth's crust, the compounds of which make water hard when dissolved. The presence of calcium in water is a factor contributing to the formation of scale and insoluble soap curd which are a means of clearly identifying hard water.

Calcite - The brand name of a calcium carbonate media sold by Clack Corp. Used to raise the pH of water.

capacity -An expression of the quantity of an undesirable material which can be removed by a water conditioner between cleaning regeneration or replacement, as determined under standard test conditions. For ion exchange water softeners, the capacity is expressed in grains of hardness removal between successive regenerations and is related to the pound of salt used in regeneration. For filters, the capacity may be expressed in the length of time or total gallons delivered between servicing.

carbon dioxide -A gas present in the atmosphere and formed by the decay of organic matter; the gas in carbonated beverages; in water it forms carbonic acid.

cation- An ion with a positive electrical charge, such as calcium, magnesium and sodium.

cation exchange - Ion exchange process in which cations in solution are exchanged for other cations from an ion exchanger.

caustic- Any substance capable of burning or destroying animal flesh or tissue.

caustic soda - The common name for sodium hydroxide.

chelate- To form a complex chemical compound in which an ion, usually metallic, is bound into a stable ring structure.

chlorine - A gas, Cl₂, widely used in the disinfection of water and as an oxidizing agent for organic matter, iron, etc.

coagulant - A material, such as alum, which will form a gelatinous precipitate in water, and cause the agglomeration of finely divided particles into larger particles which can then be removed by settling and/or filtration.

conductive - The quality or power to carry electrical current; in water, the conductivity is related to the concentration of ions capable of carrying electrical current.

conductivity - A measure of the ability of a solution to carry electricity; the reciprocal of the electrical resistance. The unit of conductance is the ohm (reciprocal ohm).

corrosion - The destructive disintegration of a metal by electrochemical means.

Corosex - The brand name of a magnesium oxide media sold by Clack Corp. Used to raise the pH of water.

cycle - A series of events or steps which ultimately lead back to the starting point, such as the exhaustion-regeneration cycle of an ion exchange system; sometimes incorrectly used in reference to a single step of a complete cycle.

CT values - Refers to Concentration X Time value set by EPA and WHO guidelines for the disinfection of water. To find the CT value, multiply the chemical in PPM by the time of contact. CT values vary for different disinfectants, bacteria, viruses, etc.

deionization - The removal of all ionized minerals and salts (both cationic and anionic) from a solution by a two-phase ion exchange procedure. First, positively charged ions are removed by a cation exchange resin for a chemically equivalent amount of hydrogen ions. Second, negatively charged ions are removed by an anion exchange resin for a chemically equivalent amount of hydroxide ions. The hydrogen and hydroxide ions introduced in this process unite to form water molecules. The term is often used interchangeably with demineralization.

demineralization - The removal of ionized inorganic minerals and salts (not organic materials) from a solution by a two-phase ion exchange procedure; similar to deionization, and the two terms are often used interchangeably.

D.I. or DI - Abbreviation for "deionization".

disinfection - A process in which pathogenic (disease producing bacteria) are killed; may involve disinfecting agents such as chlorine, or physical processes such as heating.

dissolved solids - The weight of matter in true solution in a stated volume of water; includes both inorganic and organic matter; usually determined by weighing the residue after evaporation of the water at 105 or 180 degrees Celcius.

distillation - The process in which a liquid, such as water, is converted into its vapor state by heating, and the vapor cooled and condensed to the liquid state and collected; used to remove solids and other impurities from water, multiple distillations are required for extreme purity.

equivalent per million - A unit of concentration used in chemical calculations, calculated by dividing the concentration in PPM or mg/l by the equivalent weight.

exhaustion - The state of an ion exchange material in which it is no longer capable of effective function due to the depletion of the initial supply of exchangeable ions; the exhaustion point may be defined in terms of a limiting concentration of matter in the effluent, or in the case of demineralization, in terms of electrical conductivity.

filter - Specifically, a device or system for the removal of solid particles (suspended solids); in general, includes mechanical, adsorptive, oxidizing and neutralizing filters.

flocculation - The agglomeration of finely divided suspended solids into larger, usually gelatinous, particles; the development of a "floc" after treatment with a coagulant by gentle stirring or mixing.

flow control - A device designed to limit the flow of water or regenerant to a predetermined value over a broad range of inlet water pressures.

flow rate - The quantity of water or regenerant which passes a given point in a specified unit of time, often expressed in gallons per minute.

fluoridation - The addition of a fluoride compound to a water supply to produce the concentration desired for the reduction in incidence of dental caries.

fouling - The process in which undesirable foreign matter accumulates in a bed of filter media or ion exchanger, clogging pores and coating surfaces and thus inhibiting or retarding the proper operation of the bed.

freeboard - The vertical distance between a bed of filter media or ion exchange material and the over flow collector for backwash water; the height above the bed of granular media available for bed expansion during backwashing; may be expressed either as a linear distance or a percentage of bed depth.

GPG - Abbreviation for "grain per gallon".

grain(gr.)- A unit of weight equal to 1/7000th of a pound, or 0.0648 gram.

grain per gallon(GPG)- A common basis for reporting water analyses in the United States and Canada; one grain per U.S. gallon equals 17.12 milligrams per liter (mg/L) or parts per million (PPM).

gram(g) - The basic unit of weight (mass) of the metric system, originally intended to be the weight of 1 cubic centimeter of water at 4°C.

greensand - A natural mineral, primarily composed of complex silicates, which possess ion exchange properties.

hardness - A characteristic of natural water due to the presence of dissolved calcium and magnesium; water hardness is responsible for most scale formation in pipes and water heaters, and forms insoluble "curd" when it reacts with soaps. Hardness is usually expressed in grains per gallon, parts per million, or milligrams per liter, all as calcium carbonate equivalent.

hard water - Water with a total hardness of one grain per gallon or more, as calcium carbonate equivalent.

hydraulic - Referring to water or other fluids in motion.

hydraulic classification- A process in which particles of the same specific gravity may be graded according to size by backwashing or other relative upward flow of water, with the smallest particles tending to rise to the top, because of variations in weight to surface area ratios.

hydrologic cycle - The water cycle, including precipitation of water from the atmosphere as rain or snow, flow of water over or through the earth, and evaporation or transpiration to water vapor in the atmosphere.

ion exchange - A reversible process in which ions are released from an insoluble permanent material in exchange for other ions in a surrounding solution; the direction of the exchange depends upon the affinities of the ion exchanger for the ions present, and the concentrations of the ions in the solution.

ion exchanger - A permanent, insoluble material which contains ions that will exchange reversibly with other ions in a surrounding solution. Both cation and anion exchangers are used in water conditioning.

ionization - The process in which atoms gain or lose electrons and thus become ions with positive or negative charges; sometimes used as synonymous with dissociation, the separation of molecules into charged ions in solution.

iron - An element often found dissolved in ground water (in the form of ferrous iron) in concentrations usually ranging from zero to 10 PPM (mg/L). It is objectionable in water supplies because of the staining caused after oxidation and precipitation (as ferric hydroxide), because of tastes, and because of unsightly colors produced when iron reacts with tannins in beverages such as coffee and tea.

iron bacteria - Organisms which are capable of utilizing ferrous iron - either from the water or from steel pipe - in their metabolism, and precipitating ferric hydroxide in their sheaths and gelatinous deposits. These organisms tend to collect in pipe lines and tanks during periods of low flow, and to break loose in slugs of turbid water to create staining, taste and odor problems.

Langelier's index - A calculated number used to predict whether or not a water will precipitate, be in equilibrium with, or dissolve calcium carbonate. It is sometimes erroneously assumed that any water which tends to dissolve calcium carbonate is automatically corrosive.

lime - The common name for calcium oxide (CaO); hydrated lime is calcium hydroxide Ca(OH)₂.

lime scale - Hard water seal containing a high percentage of calcium carbonate.

limestone - A sedimentary rock, largely calcium carbonate, and usually also containing significant amounts of magnesium carbonate.

liter - The basic metric unit of volume; 3.785 liters equals 1 U.S. gallon; 1 liter of water weights 1000 grams.

magnesium - One of the elements making up the earth's crust, the compounds of which make water hard when dissolved. The presence of magnesium in water is a factor contributing to the formation of scale and insoluble soap curds.

manganese - An element sometimes found dissolved in ground water, usually with dissolved iron but in lower concentrations; causes black stains and other problems similar to iron.

manganese greensand - Greensand which has been processed to incorporate in its pores and on its surface the higher oxides of manganese. The product has a mild oxidizing power, and is often used in the oxidation and precipitation of iron, manganese and/or hydrogen sulfide, and their removal from water.

Pro-OX, MangOX - The brand name of a catalytic iron filter media.

media - The selected materials in a filter that form the barrier to the passage of certain suspended solids or dissolved molecules.

micron - A linear measure equal to one millionth of a meter.

milligram per liter (mg/L) - A unit concentration of matter used in reporting the results of water and wastewater analyses. In dilute water solutions, it is practically equal to the part per million, but varies from the PPM in concentrated solutions such as brine. As most analyses are performed on measured volumes of water, the mg/L is a more accurate expression of the concentration, and is the preferred unit of measure.

mineral - A term applied to inorganic substances, such as rocks and similar matter found in the earth's strata, as opposed to organic substances such as plant and animal matter. Minerals normally have definite chemical composition and crystal structure. The term is also applied to matter derived from minerals, such as inorganic ions found in water. The term has been incorrectly applied to ion exchangers, even though most modern materials are organic ion exchange resins.

molecule - The simplest combination of atoms that will form a specific chemical compound; the smallest particle of a substance which will still retain the essential composition and properties of that substance, and which can be broken down only into atoms and simpler substances.

neutral - In electrical systems, the term used to indicate neither an excess nor a lack of electrons; a condition of balance between positive and negative charges. In chemistry, the term used to indicate a balance between acids and bases; the neutral point on the pH scale is 7.0 indicating the presence of equal numbers of free hydrogen (acidic) and hydroxide (basic) ions.

neutralization - In general, the addition of either an acid or a base to a solution as required to produce a neutral solution. The use of alkaline or basic materials to neutralize the acidity of some waters is a common practice in water conditioning.

noncarbonate hardness- Water hardness due to the presence of compounds such as calcium and magnesium chlorides, sulfates, or nitrates; the excess of total hardness over total alkalinity.

operating pressure - The range of pressure, usually expressed in pounds per square inch, over which a water conditioning device or water system is designed to function.

osmosis - Process of diffusion of a solvent such as water through a semi-permeable membrane which will transmit the solvent but impede most dissolved substances. The normal flow of solvent is from the dilute solution to the concentrated solution.

oxidation - A chemical process in which electrons are removed from an atom, ion or compound. The addition of oxygen is a specific form of oxidation. Combustion is an extremely rapid form of oxidation, while the rusting of iron is a slow form.

particle size - As used in industry standards, the size of a particle suspended in water as determined by its smallest dimension, usually expressed in microns.

parts per million (PPM) - A common basis for reporting the results of water and wastewater analysis, indicating the number of parts by weight of a dissolved or suspended constituent, per million parts by weight of water or other solvent. In dilute water solutions, one part per million is practically equal to one milligram per liter, which is the preferred unit.

pathogen - An organism which may cause disease.

PPM - The abbreviation for "part per million".

precipitate - To cause a dissolved substance to form a solid particle which can be removed by settling or filtering, such as in the removal of dissolved iron by oxidation, precipitation, and filtration. The term is also used to refer to the solid formed, and to the condensation of water in the atmosphere to form rain or snow.

Pyrolox - The brand name of a catalytic iron filter media.

rated capacity - The basis for calculating the period of time, or number of gallons delivered by a water softener or filter, between regenerations or servicing, as determined under specific test conditions.

rated service flow - The manufacturer's specified maximum flow rate at which a water softener will deliver soft water or a filter will deliver quality water as specified for its type, as determined under standard test conditions. A manufacturer may also specify a minimum flow rate or a range of service flows.

raw water- Untreated water, or any water before it reaches a specific water treatment device or process.

red water - Water which has a reddish or brownish appearance due to the presence of precipitated iron and/or iron bacteria.

regenerant - A solution of a chemical compound used to restore the capacity of an ion exchange system. Sodium chloride brine is used as a regenerant for ion exchange water softeners, and acids and bases are used as regenerants for the cation and anion resins used in demineralization.

residual - The amount of a specific material remaining in the water following a water treatment process. May refer to material remaining as a result of incomplete removal or to material meant to remain in the treated water.

resin- Synthetic organic ion exchange material, such as the high capacity cation exchange resin widely used in water softeners.

reverse osmosis - A process for the removal of dissolved ions from water in which pressure is used to force the water through a semi-permeable membrane which will transmit the water but reject most other dissolved materials.

saline water - Water containing an excessive amount of dissolved salts, usually over 10,000 mg/L.

salt - The common name for the specific chemical compound sodium chloride used in the regeneration of ion exchange water softeners. In chemistry, the term is applied to a class of chemical compounds which can be formed by the neutralization of an acid with a base.

sequester - A chemical reaction in which certain ions are bound into a stable, water soluble compound, thus preventing undesirable action by the ions.

sequestering agent- A chemical compound sometimes fed into water to tie up undesirable ions, keep them in solution, and eliminate or reduce the normal effects of the ions. For example, polyphosphates can sequester hardness and prevent reaction with soap.

soap - One of a class of chemical compounds which possesses cleaning properties, formed by the reaction of a fatty acid with a base or alkali. Sodium and potassium soaps are soluble and useful, but can be converted to insoluble calcium and magnesium soaps (curd) by the presence of these hardness ions in water.

soda ash - The common name for sodium carbonate, a chemical compound used as an alkaline builder in some soap and detergent formulations, to neutralize acid water, and in the lime-soda ash water treatment process.

sodium - An ion found in natural water supplies, and introduced to water in the ion exchange water softening process. Sodium compounds are highly soluble, and do not react with soaps or detergents.

sodium chloride - The chemical name for common salt, widely used in the regeneration of ion exchange water softeners.

soft water - Any water which contains less than 1.0 gpg (17.1 mg/L) of hardness minerals, expressed as calcium carbonate.

solvent - The liquid, such as water, in which other materials (solutes) are dissolved.

specific gravity - The ratio of the weight of a specific volume of a substance compared to the weight of the same volume of pure water at 4°C.

sulfate-reducing bacteria- A group of bacteria which are capable of reducing sulfates in water to hydrogen sulfide gas, thus producing obnoxious tastes and odors. These bacteria have no sanitary

significance, and are classed as nuisance organisms.

sulfur - A yellowish solid element. The term is also used as a slang expression to refer to water containing hydrogen sulfide gas.

TDS - The abbreviation for "total dissolved solids."

total acidity - The total of all forms of acidity, including mineral acidity, carbon dioxide, and acid salts. Total acidity is usually determined by titration with a standard base solution to the phenolphthalein endpoint (pH 8.3).

total alkalinity - The alkalinity of a water is determined by titration with standard acid solution to the methyl orange endpoint (pH approximately 4.5); sometimes abbreviated as "M alkalinity". Total alkalinity includes many alkalinity components, such as hydroxides, carbonates, and bicarbonates.

total dissolved solids- The weight of solids per unit volume of water which are in true solution, usually determined by the evaporation of a measured volume of filtered water, and determination of the residue weight.

total hardness- The sum of all hardness constituents in a water, expressed as their equivalent concentration of calcium carbonate. Primarily due to calcium and magnesium in solution, but may include small amounts of metals such as iron, which can act like calcium and magnesium in certain reactions.

total solids - The weight of all solids, dissolved and suspended, organic and inorganic, per unit volume of water, usually determined by the evaporation of a measured volume of water at 105 degrees Celsius in a pre-weighed dish.

turbidity - A measure of the amount of finely divided suspended matter in water, which causes the scattering and adsorption of light rays.

ultrafiltration - A method of crossflow filtration (similar to reverse osmosis but using lower pressures) which uses a membrane to separate small colloids and large molecules from water and other liquids. The ultrafiltration process falls between reverse osmosis and microfiltration in terms of the size of particles removed, with ultrafiltration removing particles in the 0.002 to 0.1 micron range, and typically rejecting organics over 1,000 molecular weight while passing ions and smaller organics.

ultrapure water - Highly-treated water that is deionized and mineral-free with high resistivity and no organics; it is usually used in the semiconductor and pharmaceutical industries. Ultrapure water is NOT considered biologically pure (potable) or sterile. There is no set numerical standard to determine exactly what "ultrapure" water is or should be.

ultraviolet (UV) - Pertaining to ultraviolet light.

ultraviolet absorber- Substances which absorb ultraviolet radiation (light). Ultraviolet absorbers are added to plastic (such as those used in plastic tanks and fittings) and rubber products to make them less likely to decay as the result of absorbing ultraviolet rays.

ultraviolet chamber- The area where the water is irradiated with ultraviolet rays.

ultraviolet demand - The amount of ultraviolet rays required to inactivate certain microorganisms.

ultraviolet dosage - The amount of disinfectant ultraviolet rays delivered to the organisms in the water being disinfected. Dosage is the product of UV intensity times the contact time and is measured in watt-seconds per square centimeter.

ultraviolet (UV) light- Radiation (light) having a wavelength shorter than 3900 angstroms, the wavelengths of visible light, and longer than 100 angstroms, the wavelengths of x-ray's. This wavelength puts ultraviolet light at the invisible violet end of the light spectrum. Ultraviolet light is used as a disinfectant.

unaccounted-for water- A term used by public and municipal water systems to describe the difference between the amount of finished water produced and the amount registered on meters as sold. Unaccounted-for water may range from 10 percent to 35 percent of finished water produced by the utility and usually includes water lost from leaky water mains, water lost in firefighting or from fire hydrants, or other public or municipal uses.

uncertainty factor - A number (equal to or greater than one) used to divide the NOAEL or LOAEL value derived from measurements in animals or small groups of humans, in order to estimate a NOAEL value for the whole human population.

unconfined aquifer - An aquifer confining water that is not under pressure; the water level in a well is the same as the water table outside the well.

underbed - A layer of gravel or grout used to fill the bottom curved base of a larger filter or softener tank, usually in a system with a header-lateral design. Underbed is not the same per se as the media support bed.

underdrain- The drainage piping arrangement to collect treated water at the bottom of the ion exchange or filter media beds.

uniform flow - A flow in which the feet per second velocity rates and directions are the same from point to point along the conduit.

uniformity coefficient - The measure of the variation in particle sizes of filter and ion exchange media. The uniformity coefficient is defined as the ratio of the sieve size that will permit passage of 60 percent of the media material by weight to the sieve size that will permit passage of 10 percent of the media material by weight. A uniformity coefficient of 1.00 denotes a material having particle grains all the same size; numbers increasingly greater than one denote increasingly less uniformity.

uniform particle size- The particle size distribution screen sizing for exchanger and filtration media as established by U.S. Mesh Standards.

unit cancer risk - Estimate of the lifetime risk caused by each unit of exposure in the low exposure region.

United States Pharmacopeia (USP)- The official publication for drug product standards including six water quality standards for pharmaceutical uses. The USP was established by the U.S. Congress in 1884 to control makeup of drugs.

unit hydrograph- The hydrograph of one inch of storm runoff generated by a rainstorm of fairly uniform intensity within a specific period of time.

univalent - Having a valence of one. Also called monovalent.

unsaturated zone - The area between the land surface and water table in which the pore spaces are only partially filled with water. Also called "zone of aeration."

unslaked lime – *SEE lime.*

upflow - A pattern of water flow in which a solution (water or regenerant usually) enters at the bottom of the vessel or column and flows out at the top of the vessel or column during any phase of the treatment unit's operating cycle. The term is used to describe ion exchange system flow patterns or water flow through filter media. A system can have upflow during the treatment cycle and downflow during regeneration. Upflow is also called countercurrent flow. Countercurrent flow means regeneration flows and service flows are in the opposite directions.

upflow brining - Is a means of forcing the brine solution upward through the cation exchanger for regenerating the resin. Where the softening flow is downward and the regenerating brine flow is upward, the mode is also called countercurrent flow. Countercurrent flow means regeneration flows and service flows are in the opposite directions.

upflow softening - A pattern of water flow used in softeners in which the service water flows upward through the ion exchange bed; the media is restricted in movement, usually because of a packed bed. The regeneration brine usually flows downward in such systems. Upflow softening is normally used to achieve higher operating efficiency.

upper bound estimate - Estimate not likely to be lower than the true risk.

upper distributor - The piping arrangement inside and at the top of softeners and filters to more uniformly distribute the incoming water over the resin or filter media bed. In small domestic units, this distributor also distributes the brine for regeneration.

uranium (U) - A radioactive metallic element found naturally only in combination with other substances. Uranium 238 (U-238) is the most common form, but about 0.7 percent of natural uranium is present as U-235, which is the important fissionable component in work with atomic energy. Uranium in natural water exists as anionic complexes $\text{UO}_2(\text{CO}_3)_2^{2-}$ and $\text{UO}_2(\text{CO}_3)_3^{4-}$.

urban runoff – Storm water from city streets and adjacent domestic or commercial properties that may carry pollutants of various kinds into the sewer systems and/or receiving waters.

user - The water product consumer.

user fee - A fee which is collected only from those persons who use a particular service, as opposed to one collected from the public in general. User fees generally vary in proportion to the degree of use of the service.

USP - United States Pharmacopeia.

USTs - Underground Storage Tanks.

vacuum breaker - A mechanical device which automatically vents a water line to the atmosphere when subject to a partial vacuum, thus preventing back-siphoning.

vacuum distillation - Distillation that occurs at a pressure somewhat below atmospheric pressure. Lowering the pressure also lowers the boiling point of water, thus conserving energy by requiring less heat to bring about distillation.

vacuum filtration - The filtration process in which a partial vacuum is applied to increase the rate of filtration by causing the water to be sucked through the filter medium. This is one of the oldest mechanical dewatering techniques in continuous use. In municipal softening, this process is used to separate water from the lime sludge for sludge disposal.

vacuum freezing - A form of desalination that uses a vacuum to help cool and quickly freeze high TDS

source water, and separates the solids by concentrating them in the portion of the water that doesn't freeze or that freezes last in a similar manner to what occurs in the cloudy centers of ice cubes.

vacuum pan - An airtight container used to produce granulated water softener salt using a process involving the evaporation of brine-turned-to-steam in a partial vacuum.

vacuum pump- A pumping apparatus which exhausts gas or air from an enclosed space to achieve a desired degree of vacuum.

valence - A whole number (positive or negative) representing the power of one element to combine with another. In general terms, the valence number represents the number of electrons in an atom or combined group of atoms which can be easily given up or accepted to react with or bond to another atom or group of atoms to form a molecule.

validation - 1. (water treatment industry) Determination upon testing that a representative sample of a water treatment equipment model has met the requirements of a specified standard. 2. (pharmaceutical industry) The requirement of certain quality control testing and record keeping procedures to ensure compliance not only with a specific quality but also with a specific means to achieve and ensure that quality.

Van Der Waal's forces- Weak attractive forces acting between molecules. These forces are somewhat weaker than hydrogen bonds and far weaker than inter-atomic valences.

vapor- 1. The gaseous form of any substance whose usual form is a liquid or a solid. 2. Visible particles of moisture suspended in air, such as mist or fog.

vapor pressure- The pressure, often expressed in millimeters of mercury (mm Hg) at which a vapor is in a state of balance with its liquid or solid form.

variable costs- Input costs that change as the nature of the production activity of its circumstances change; for example, as production levels vary.

variance- A State with primary enforcement responsibility under the Safe Drinking Water Act may relieve a public water system from a requirement respecting an MCL by granting a variance if certain conditions exist. These are: 1) the system cannot meet the MCL in spite of the application of best available treatment technology, treatment techniques, or other means (taking costs into consideration), due to the characteristics of the raw water sources which are reasonably available to the system, and 2) the variance will not result in an unreasonable public health risk. A system may also be granted a variance from a specified treatment technique if it can show that, due to the nature of the system's raw water source, such treatment is not necessary to public health.

vegetative controls - Nonpoint source pollution control practices that utilize vegetative cover to reduce erosion and minimize the loss of pollutants.

velocity (general water treatment) - The time measurement of linear motion (flow) in a given direction. For example, water flowing 60 feet in a conduit each minute has a velocity of 60 feet per minute (fpm) or one foot per second (1 fps).

velocity profile- The relationship between the velocity of fluid flowing adjacent to the conduit wall or membrane surface and that flowing at a distance from the wall or surface.

venturi - A tube with a narrow throat (a constriction) that increases the velocity and decreases the pressure of the liquid passing through it, creating a partial vacuum immediately after the constriction in the tube. The vacuum created has a sucking effect (eduction), and a venturi is commonly used to introduce a liquid (such as a regenerant) or gas (such as air) into a flowing water stream.

versenate - A chemical substance used in water analysis for water hardness or with an indicator to measure hardness quality by the water's color

viable - 1. Capable of living independently (as in a fetus capable of living outside the womb) and being reproductive (as microorganisms capable of colonizing and thriving) 2. workable (as a viable idea).

viable treatment process- A water or waste water treatment process capable of accomplishing the desired water quality.

virulence - Degree of ability to cause disease.

virus - A parasitic infectious microbe, composed almost entirely of protein and nucleic acids, which can cause disease(s) in humans. Viruses can reproduce only within living cells. They are 0.004 to 0.1 microns in size, and about 100 times smaller than bacteria.

viscosity - The tendency of a fluid to resist flowing due to internal forces such as the attraction of the molecules for each other (cohesion) or the friction of the molecules during flow. Viscosity varies with water temperature.

VOCs - Volatile Organic Chemicals.

voids - *SEE*void volume.

void volume - The volume occupied by the interstitial spaces between the particles of ion exchangers, filter media, or other granular materials in a bed or column. Often expressed as percent of the total volume occupied by the medium bed.

volatile - Capable of becoming vapor at relatively low temperatures.

volatile acids - Acids produced during digestion. Fatty acids which are soluble in water and can be steam-distilled at atmospheric pressure. Also called organic acids. Volatile acids are commonly reported as equivalent to acetic acid.

volatile liquids - Liquids which easily vaporize or evaporate at room temperatures.

volatile organic chemicals (VOCs)- Organic chemicals that turn into vapor at relatively low temperatures.

volatile solids - The term used in the laboratory analysis of the solid contents of a substance (such as water) to define the portion of the total suspended and/or dissolved solids that become expelled or driven off after heating or burning a given sample of the substance at a specified temperature and for a specified time.

volatilization - Loss of a substance through evaporation.

voltage - The electrical pressure available to cause a flow of current (amperage) when an electrical circuit is closed.

volumetric - A measurement based on the volume of some factor. Volumetric titration is a means of measuring unknown concentrations of water quality indicators in a sample by determining the volume of titrant or liquid reagent needed to complete particular reactions.

vortex- A revolving mass of water which forms a whirlpool. This whirlpool is caused by water flowing out of a small opening in the bottom of a basin or reservoir. A funnel-shaped opening is created downward from the water surface.

waste water- 1. The stream of water (not product water) created as the result of processing water-the reject water or concentrate, 2. (ion exchange and filtration) The spent water used in the total backwash and/or regeneration cycle, 3) The used water and solids from a residence or a community (including used water from industrial processes) that flow to a septic system or a treatment plant. Storm water, surface water, and groundwater infiltration also may be included in the waste water that enters a waste water treatment plant. The term sewage usually refers to household wastes, but this word is being replaced by the term waste water.

waste water treatment plant- A facility that receives waste waters (and sometimes runoff) from domestic and/or industrial sources, and by a combination of physical, chemical, and biological processes reduces (treats) the waste water to less harmful byproducts; known by the acronyms WWTP, STP (sewage treatment plant), and POTW (publicly owned treatment works).

water (H₂O) - An odorless, colorless, tasteless liquid which exists as ice in solid form (phase) and steam in vapor form (phase). It freezes at 32°F (0°C) and boils at 212°F (100°C). Water is a polar liquid with high dielectric constant which accounts for its solvent power. It is called the universal solvent. It is a weak electrolyte; in pure water, only about two molecules in every 1,100,000,000 separate into H₃O⁺ and OH⁻ ions. Water is only slightly compressible. It is the liquid that descends from the clouds as rain and forms lakes, streams, and seas (oceans). Water is a major constituent of all living matter. Also referred to as H₂O (dihydrogen oxide) and HOH (hydrogen hydroxide).

water bloom- A prolific growth of plankton, including blue-green algae, which may occur and be so dense that it imparts a greenish, yellowish, or brownish color to water near the surface of a lake, pond, or reservoir.

waterborne disease- A disease, caused by a bacterium or organism able to live in water, which can be transmitted by water.

waterborne disease outbreak - The significant occurrence of acute infectious illness, epidemiologically associated with the ingestion of water from a public water system that is deficient in treatment, as determined by the appropriate local or state agency.

water budget- A summation of inputs, outputs, and net changes to a particular water resource system over a fixed period. (Also, water balance model.)

water closet- A flushable toilet.

water conditioning - The treatment or processing of water, by any means, to modify, enhance, or improve its quality or to meet a specific water quality need, desire, or set of standards. Also called water treatment.

water cycle - *SEE* [hydrologic cycle](#).

water density (maximum)- The maximum density of water is reached at 39°F (4°C). It becomes less dense at both higher and lower temperatures.

water flooding - A process in underground mining such as oil recovery in which oil or a mineral from underground formations is replaced by an infusion of warm, softened water thus bringing the underground substance to the surface for recovery. Also known as oil well flooding.

water glass - The common name of a sodium silicate (Na₂O • xSiO₂) substance used for corrosion control in potable waters. It is also an ingredient used in the manufacture of synthetic gel zeolite.

water hammer - The shock wave or series of waves caused by the resistance of inertia to an abrupt

change (acceleration or deceleration) of water flow through a water piping system. Water hammer may produce an instantaneous pressure many times greater than the normal pressure. For this reason, many building codes now require the installation of a "water hammer arrestor," a device to absorb these shock waves and prevent damage to appliances such as washing machines.

water jacket- An outer casing which holds water or through which water flows and circulates to absorb heat and cool the interior of the mechanism or machinery that the water jacket is surrounding.

waterless hand cleaner - A paste, gel, or lotion that does not require rinsing. Waterless hand cleaners are useful when facilities for hand washing are not available and are also helpful in removing difficult soils. Available for use from dispensers, or directly from their own containers, they are usually oil-in-water emulsions. They are available with or without scrubbers. The scrubbers may be organic (e.g. particles of polyethylene or polystyrene) or inorganic (pumice).

waterlogged tank - A tank (as in a domestic water well pumping system) in which too much water has accumulated and has replaced some of the air in the tank's air cushion causing a disruption in the normal pressure pattern needed for pumping and uniform water flow.

water meter- An instrument, mechanical or electronic, used for recording (in gallons, cubic feet, or cubic meters) the quantity of water passing through a particular pipe line or outlet. In water processing systems, meters may initiate certain functions such as automatically starting the regeneration cycle in an ion exchange system.

water of hydration- Water which has been chemically combined with a substance to form a hydrate and which can then be removed (as by heating) without essentially changing the chemical composition of the substance.

water processing- *SEE* **water conditioning**.

water purveyor - An agency or person that supplies water (usually potable water).

water regain- *SEE* **water retention**.

water retention- The amount of water, expressed as a percentage of the wet weight of an ion exchanger, retained within the resin bead and on the surface of fully swollen and drained ion exchange media. Also called water regain.

watershed- The land area that drains into a stream. An area of land that contributes runoff to one specific delivery point; large watersheds may be composed of several smaller "subsheds", each of which contributes runoff to different locations that ultimately combine at a common delivery point.

water softener (chemical)- A compound which, when introduced into water used for cleaning or washing, will counteract the effects of the hard water minerals (calcium and magnesium) and produce the effect of softened water. For example, detergent additives and polyphosphates.

water softener (mechanical)- A pressurized water treatment device in which hard water is passed through a bed of cation exchange media (either inorganic or synthetic organic) for the purpose of exchanging calcium and magnesium ions for sodium or potassium ions, thus producing a softened water which is more desirable for laundering, bathing, and dishwashing. This cation exchange process was originally called zeolite water softening or the Permutit Process. Most modern water softeners use a sulfonated bead form of styrene/divinylbenzene (DVB) cation resin.

water softener salt - Salt suitable for regenerating residential and commercial cation exchange water softeners. Most commonly used for this purpose is sodium chloride (NaCl) in crystal or pelletized form. Rock grade salt should be 96-99 percent NaCl; evaporated salt should be 99+ percent NaCl. Potassium chloride (KCl) may also be used for the regeneration cycle in the cation exchange process, thus minimizing the amount of sodium added to both the softened water and the spent regenerant water going to the drain.

water softening - The reduction/removal of calcium and magnesium ions, which are the principal cause of hardness in water. The cation exchange resin method is most commonly used for residential and commercial water treatment. In municipal and industrial water treatment, the process can be lime softening or lime-soda softening.

water solubility- The maximum concentration of a chemical compound which can result when it is dissolved in water. If a substance is water soluble, it can very readily disperse through the environment.

water source - The basic origin of a water, either a surface source (such as a lake, river, or reservoir) or a subsurface source (such as a well). After treatment and pumping via pipe lines, the treated and pumped water becomes a water supply.

water spotting- Cloudy milk-like film, spots, streaks, or heavy white deposits left on surfaces after water has dried from them, especially noticeable on clear glassware and cars after washing. Spotting is caused by minerals that had been dissolved in the water remaining behind after the water has evaporated away. Soft water spotting can be wiped off easily with a damp cloth or rinsed off with a little fresh water. Hard water deposits, on the other hand, are comprised of the more tenacious calcium and magnesium salts. Hard water films typically require harsh abrasives or an acid cleaner to remove them. A third type of water residue film is due to silica (SiO₂) deposits. Silica spotting is rare, but it is more difficult or impractical to be removed when it does occur. If glassware films won't dissolve in acids such as vinegar or lemon juice, they may be due to silica spotting or etching. If the spot won't dissolve in acid, but can be scratched off with a razor blade or pinpoint, it's likely a silica

film.

water storage pond - An impound for liquid wastes, so designated as to accomplish some degree of biochemical treatment of the wastes.

water supplier- A person who owns or operates a public water system.

water supply system - The collection, treatment, storage, and distribution of potable water from source to consumer.

water table- The level of groundwater. The upper surface of the zone of saturation of groundwater above an impermeable layer or soil or rock (through which water cannot move) as in an unconfined aquifer. This level can be very near the surface of the ground or far below it. *SEE ALSO zone of saturation.*

water treatment - *SEE water conditioning.*

water treatment device- Any point-of-use or point-of-entry instrument or contrivance sold or offered for rental or lease for residential use, and designed to be added to the plumbing system, or used without being connected to the plumbing of a water supply intended for human consumption in order to improve the water supply by any means, including, but not limited to, filtration, distillation, adsorption, ion exchange, reverse osmosis, or other treatment.

water treatment lagoon- An impound for liquid wastes, so designed as to accomplish some degree of biochemical treatment of the wastes.

watertight - A condition existing in water treatment equipment and materials of such precision of construction and fit as to be impermeable to water unless sufficient pressure occurs to cause rupture.

water well - An excavation where the intended use is for the location, acquisition, development, or artificial recharge of groundwater (excluding sandpoint wells).

watt - A unit of power equal to one joule per second. The power of a current of one ampere flowing across a potential difference of one volt.

WBA - Weak base anion exchanger.

weak acid cation exchangers - Those cation exchange products with functional groups which, in the hydrogen form, are not capable of splitting neutral salts to form their corresponding free acids. Weak acid cation exchange resins have a much higher (three to four times higher) regeneration efficiency than their strong acid counterparts, but in the hydrogen form can only exchange cations that are associated with alkalinity. The cations associated with sulfates, chlorides, and nitrates, for example,

cannot be removed with weak acid cation exchanger in the hydrogen form. Hydrogen form weak acid cation exchangers that have been neutralized with sodium hydroxide to the sodium form, however, can effectively remove both carbonate and noncarbonate water hardness cations; thus weak acid cation resins can be used to soften waters that, because of high total dissolved solids, are not possible or practical to treat with strong acid cation resins.

weak base anion exchangers- Those anion exchange products with functional groups which are not capable of splitting neutral salts to form corresponding free bases, weak base anion exchange resins have a much higher (three to four times higher) regeneration efficiency than their strong base counterparts, but can only exchange mineral acid anions such as sulfate, chloride, and nitrate. The anions associated with weak acids, such as carbonates, bicarbonates, silicates, and organic acids, for example, cannot be removed with weak base anion exchange.

weight concentration ratio (ultrafiltration)- The ratio of the initial weight of the feedwater to the weight of the reject water remaining at any time during the ultrafiltration process.

weir- 1. A dam-like wall or plate placed in an open channel and used to measure the flow of water. The depth of the flow over the weir can be used to calculate the flow rate, or a chart or conversion table may be used. 2. A wall or obstruction used to control flow (from settling tanks and clarifiers) to assure uniform flow rate and avoid short-circuiting.

weir diameter - Many circular clarifiers have a circular weir within the outside edge of the clarifier. All the water leaving the clarifier flows over this weir. The diameter of the weir is the length of a line from one edge of a weir to the opposite edge and passing through the center of the circle formed by the weir.

weir loading- A guideline used to determine the length of weir needed on settling tanks and clarifiers in treatment plants. Used by operators to determine if weirs are hydraulically overloaded.

well - A bored, drilled, or driven shaft, or a dug hole, whose depth is greater than the largest surface dimension and whose purpose is to reach underground water supplies or oil, or to store or bury fluids below ground.

well field - Area containing one or more wells that produces usable amounts of water.

well head- A particular well site location, as differentiated from other well site locations, that exist in the same water system.

well monitoring- The measurement, by on-site instruments or laboratory methods, of the quality of water in a well.

well plug - A watertight and gastight seal installed in a bored hole or well to prevent movement of fluids.

wet chemistry- Laboratory procedures used to analyze a sample of water using liquid chemical solutions (wet) instead of, or in addition to, laboratory instruments.

wetlands - Any number of tidal and nontidal areas characterized by saturated or nearly saturated soils most of the year that form an interface between terrestrial (landbased) and aquatic environments; include freshwater marshes around ponds and channels (rivers and streams), brackish and salt marshes; other common names include swamps and bogs.

wet-salt saturator tank- A type of brine tank, so named because the saturated brine is always above the un-dissolved salt level, used on large commercial water softeners and older manual residential softeners. Most automatic home-sized water softeners now use dry-salt saturator tanks.

wetting agent- A compound that increases the ability and speed with which a liquid displaces air from a solid surface, thus improving the process of wetting that surface. Wetting agents are all surfactants. They function by lowering surface and interfacial tension. Soap and detergent surfactants serve as wetting agents in washing products, in addition to their other functions. In automatic dishwashing, nonionic surfactants are sometimes introduced into the last rinse for the purpose of maximizing drainage of water from dishes and utensils.

WFI- Water For Injection.

WHO—*SEE* **World Health Organization**.

wire-to-water efficiency- The efficiency of a pump and motor together. Also called the overall efficiency.

withdrawal - The process of taking water from a source and conveying it to a place for a particular type of use.

working pressure – *SEE* **operating pressure**.

World Health Organization- A part of the United Nations, the WHO, which is headquartered in Geneva, Switzerland, has compiled recommended standards for drinking water.

XLPE - Cross-linked polyethylene.

x-rays - 1. Electromagnetic radiation with a very short wavelength (0.01 to 12 nanometers), shorter than ultraviolet radiation. 2. An image created by short-term exposure of an object to x-rays used in

spectrometry analysis and medical therapy.

yield - 1. The amount of product water produced by a water treatment process. 2. The quantity of water (expressed as a rate of flow-GPM, GPH, GPD, or total quantity per year) that can be collected for a given use from surface or groundwater sources. The yield may vary with the use proposed, with the plan of development, and also with economic considerations.

zeolites - Hydrated sodium alumina silicates, either naturally-occurring mined products or synthetic products, with ion exchange properties. Zeolites were formerly used extensively for residential and commercial water softening but have been largely replaced by synthetic organic cation resin ion exchangers of polystyrene divinylbenzene substrate. Modified zeolites such as manganese greensand and synthetic manganese zeolites are still used as catalyst/oxidizing filters for the removal of iron, hydrogen sulfide, and manganese.

zeolite softening - A term formerly used for the removal of calcium and magnesium hardness from water by base exchange using natural or synthetic zeolites. Since the introduction of synthetic organic cation exchange resins, the more correct term is cation exchange softening. Zeolite softening was also called base exchange.

zero discharge water - A discharge limit applied to manufacturing and commercial establishments in which only normal human sanitary waste waters may be discharged to the municipal sewerage system. All other types of waste water, such as that water used in manufacturing processes, are not included in zero discharge water; but they must be recycled, and the resulting waste product from such water must be taken to an alternate and approved disposal facility.

zero soft water - Water produced by the cation exchange process and measuring less than 1.0 grain per U.S. gallon (17.1 PPM or 17.1 mg/L) as calcium carbonate.

zone of aeration - The comparatively dry soil or rock located between the ground surface and the top of the water table.

zone of saturation - The layer in the ground in which all available interstitial voids (cracks, crevices, holes) are filled with water. The level of the top of this zone is the water table. *SEE ALSO* **water table**.

zooplankton - Small, usually microscopic animals (such as protozoans), found in lakes and reservoirs.

33. Additional Resources and Links:

[Get a Professional Assistance in Selecting a Water Treatment System](#)

[EPA Private Drinking Water Wells Site](#)

[Diagrams and Schematics for a wide variety of water treatment systems](#)

[Online Water Treatment Calculators](#)

[Frequently Asked Questions About Water Treatment Systems](#)

[Water Problem Links](#)

[Well Water Test Kits](#)

[Iron and Manganese Filters](#)

[Water Quality Association](#)

[Click here to see us on Facebook for daily updates and interesting facts!](#)

The Facebook logo, consisting of the word "facebook" in white lowercase letters on a dark blue rectangular background.

This guide is provided for educational purposes only. Well quality and conditions can vary widely. Clean Water Systems & Stores Inc. neither accepts nor assumes any liability associated with the information contained in this guide. No warranty or guarantees are extended. The material contained within this ebook is protected under International and Federal Copyright Laws and Treaties, and as such, any unauthorized reprint or use of this material is prohibited with the written permission of Clean Water Systems & Stores Inc.

Technical and Product Questions Answered Fast

Have a question about your well or water? Want to know which treatment system to select, or have a question about a product on our site? Fax this form to (831) 515-5119 or [fill it out online](#) to get a fast response, often the same day!

Contact Info:

First Name: _____

Last Name: _____

E-mail: _____

Background Info:

Please give us as much background info as you wish so we can learn more about your concerns or goals regarding your water quality.

Optional Information: If you don't have any of the information below, just skip these sections; otherwise, check any that apply.

No. of Bathrooms: _____

Water Source: _____

Well Flow Rate: _____

Red, Rust, or Orange Stains _____

Brown or Black Stains _____

Blue Stains _____

White Spots / Scale _____

Sediment _____

Color _____

Sulfur Odor in Cold Well Water _____

Sulfur Odor in Hot Water Only _____

Water Has Other Odors _____

Corrosion _____

Common Water Chemistry Information:

Enter any data you may have. If you are experiencing staining, spotting, corrosion, or scaling, it's recommended you conduct the tests below.

Hardness (mg/L or PPM) _____

Hardness (grains/gallon) _____

Iron _____

Manganese _____

pH _____

Total Dissolved Solids _____

Tannin _____

Coliform Bacteria Present? _____

Fecal Coliform Bacteria Present? _____

Nitrate _____

Hydrogen Sulfide _____